

KSD-9027



SIZE: 140X90X215cm

(1)

## Cautions in Installation and Using





Thanks for selecting our shower room series. To guarantee safe and normal operation as well as prolong service lifetime. Pls read Instruction carefully before installation.

Note: Constar is dedicated to improving products quality, find something new in what is old, we would if there is difference in the Instruction until further notice. Any discomfort, we ask your pardon.



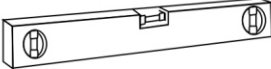

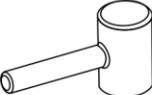
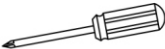

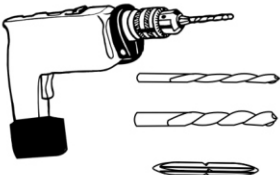

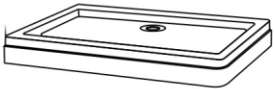
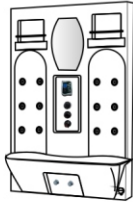

### Directory

1. Tool contents	-----	3
2. Accessory list	-----	4-6
3. Pipe and drain installation drawing	-----	7
4. Installation Procedure	-----	8-24
5. Electric appliance instruction	-----	25
6. Notes	-----	26
7. Delivery and storage notice	-----	26
8. Trouble shootings	-----	27

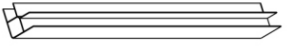
## 1. self-provide tool

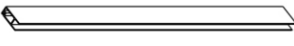







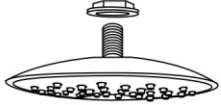

Name	Tool
Track level bar	
Tape measure	
Ajustable spanner	
Rubber hammer	
Phillips srewdriver	
Scissors	
Glass cement	
electric drill	
3mm aiguille	
6mm aiguille	
tap drill	

## 2. Partial accessory list

Item	Name	Accessory	Quantity
1	(1.1) Tub		1
	(1.2) Backboard		1
	(1.3) Roof		
2	(2.1) Side glass		2
	(2.2) Arch fixed door glass		2
	(2.3) Arch flexible door glass		2
3	(3.1) Outer side upright column		
	(3.2) Outer side upright column		2
	(3.3) upper and down rail		2
	(3.4) Small upright column		2
4	(4) Handle		2
5	(5) Foot massage device		1
6	(6) Hot and cold water pipe		2

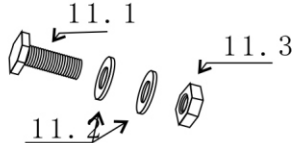
(4)

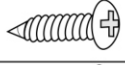
## 2. Partial accessory list

Item	Name	Accessory	Quantity
7	(7.1) handle shower pipe		1
	(7.2) handle shower head		1
	(7.3) top shower head		1
8	(8) eccentric wheel		8
9	(9.1) Magnetic strip		2
	(9.2) Waterproof seal		4
	(9.3) U style seal		2
10	(10) Glass positioning fixture		8
11	(11.1) M6X30mmscrew		8
	(11.2) spacer		
	(11.3) screw hat		
12	(12.1) St4x16mmscrew		18
	(12.2) St4x12mmscrew		8
	(12.3) St4x10mmscrew		12

(5)

### 3. Pipe and drain installation drawing

C=Cold water inlet  
H=Hot water inlet  
D=Drain



(6)

### 4. Installation Procedure

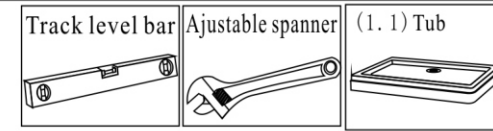

Place the bath on a solid floor and adjust the feet so that it is level. Check carefully using a spirit level.

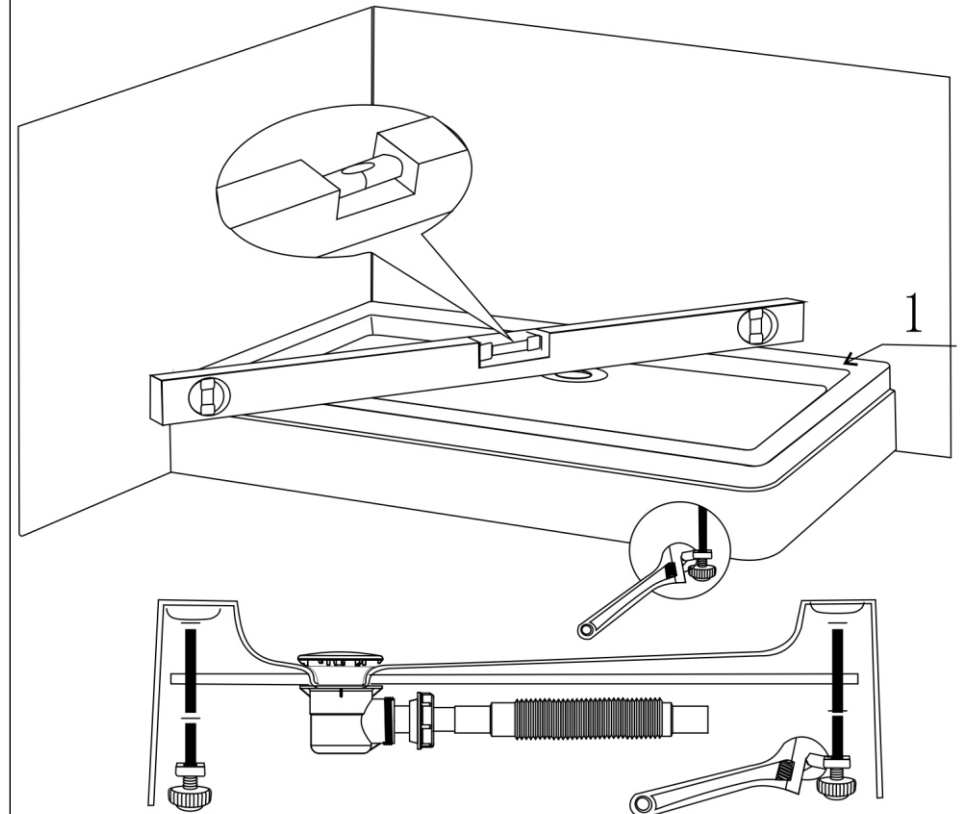

(7)

## 4. Installation Procedure

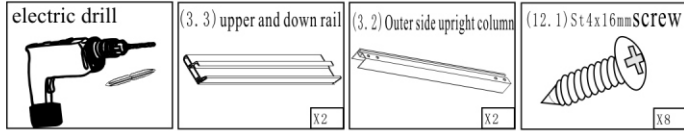

Installing the glass room frame. Take out 2 upright aluminum alloy columns and the top and bottom rails from 1/4 package. Connect them with the screws (12.1). Then put the finished frame on the tub as the “up” label at the top.

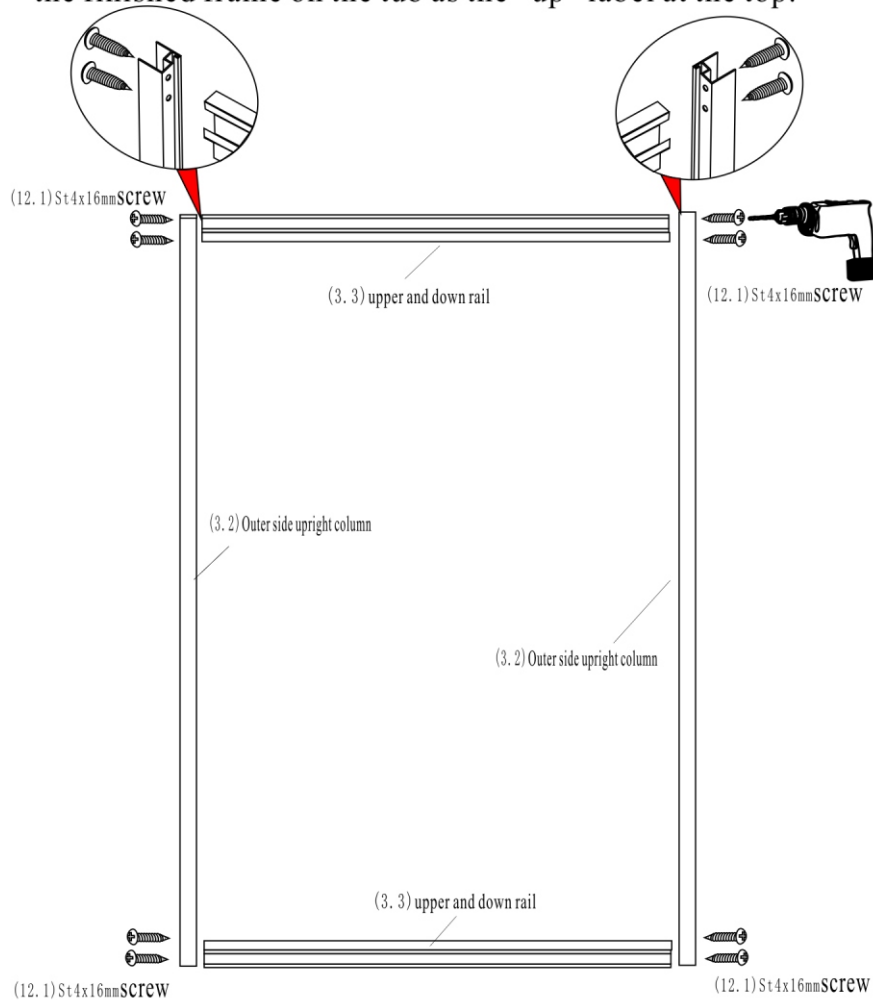

(8)

## 4. Installation Procedure

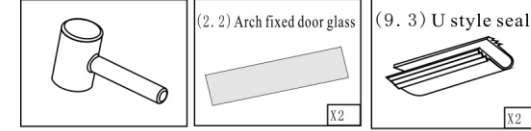

Fit the plastic sealing strips to both sides of the fixed pieces of glass (the 2 pieces of glass without any holes). You may need to trim this down to make it fit, make sure it is no longer than the glass otherwise the glass will not fit.

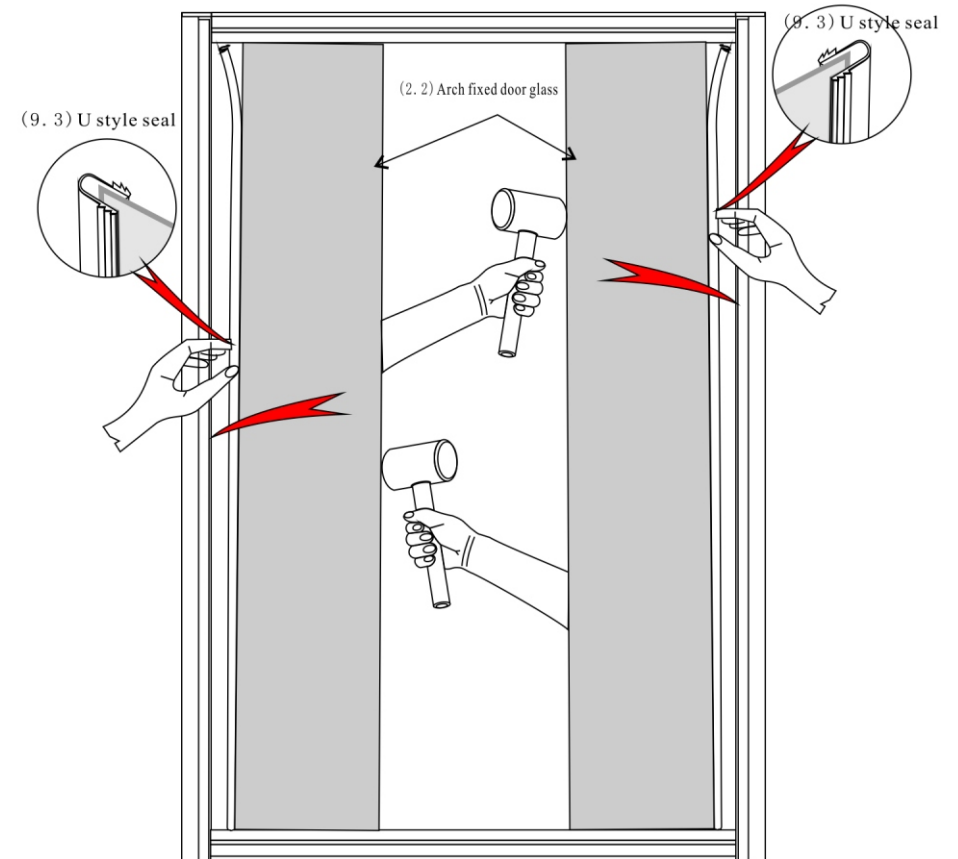

(9)

## 4. Installation Procedure

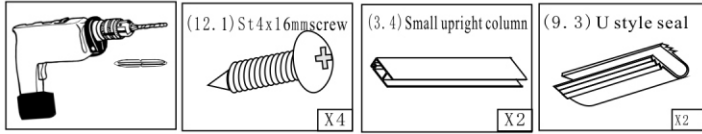

Fit U rubber seal to glass the other side, then use hammer to make the small aluminum panel (3.4) cover the glass. Then, fix the aluminum panel by screw (12.1)

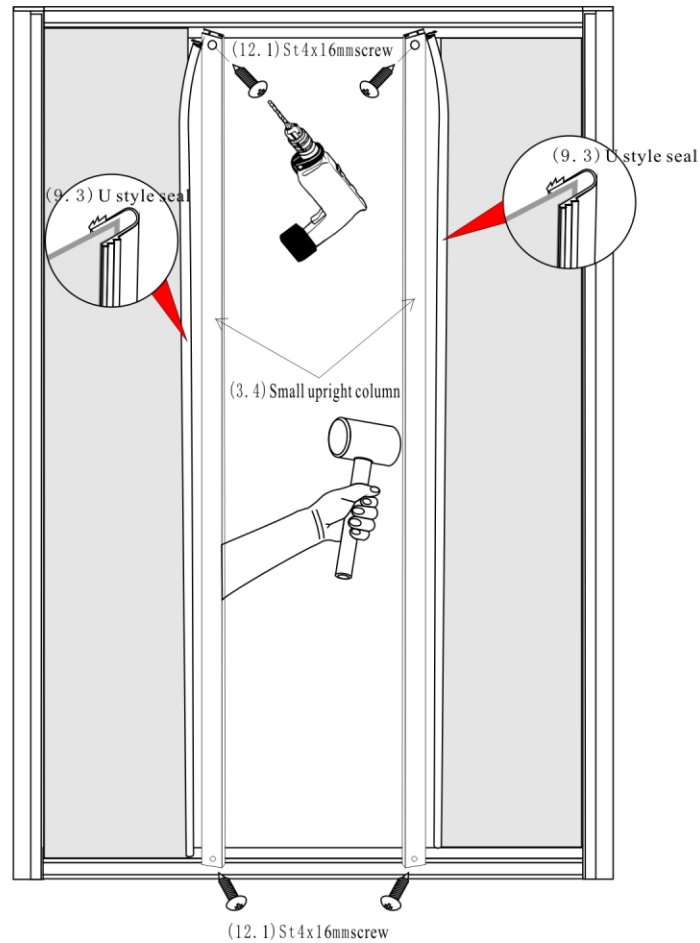

(10)

## 4. Installation Procedure

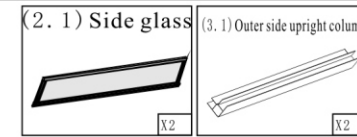

Connect the side glass with front glass frame (3.1)

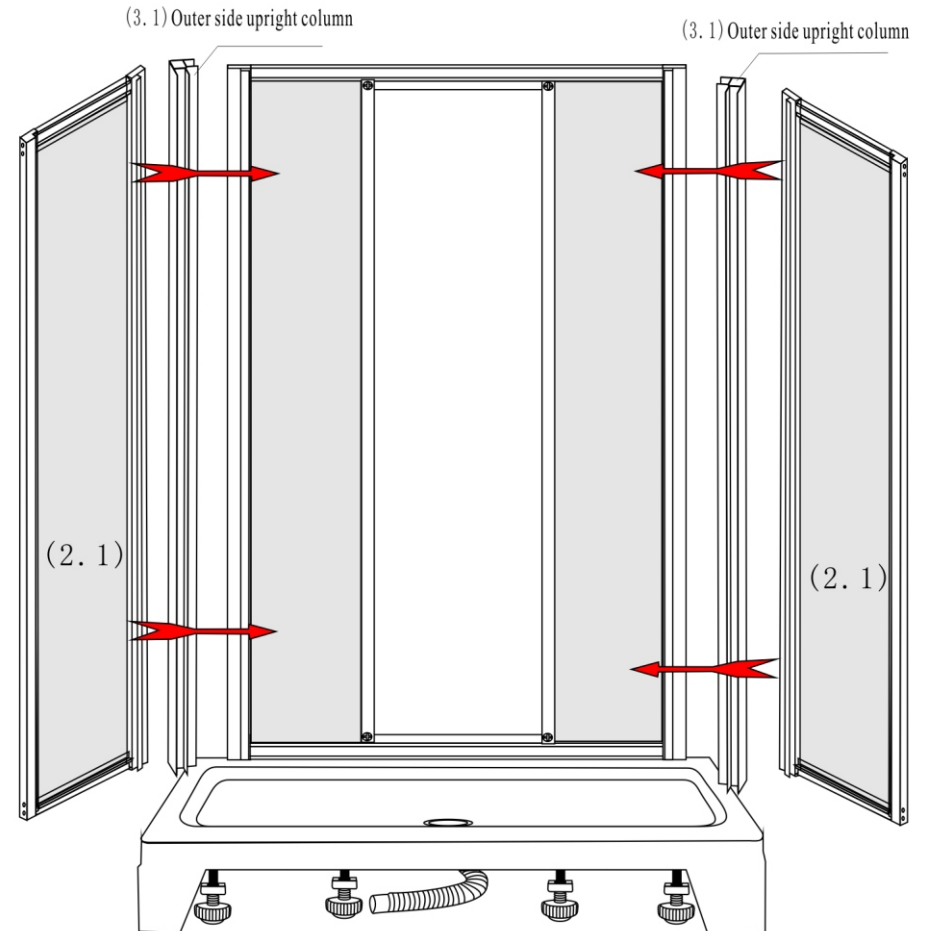

(11)

## 4. Installation Procedure

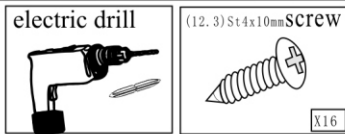

Fix the glass room by screw (12.3)

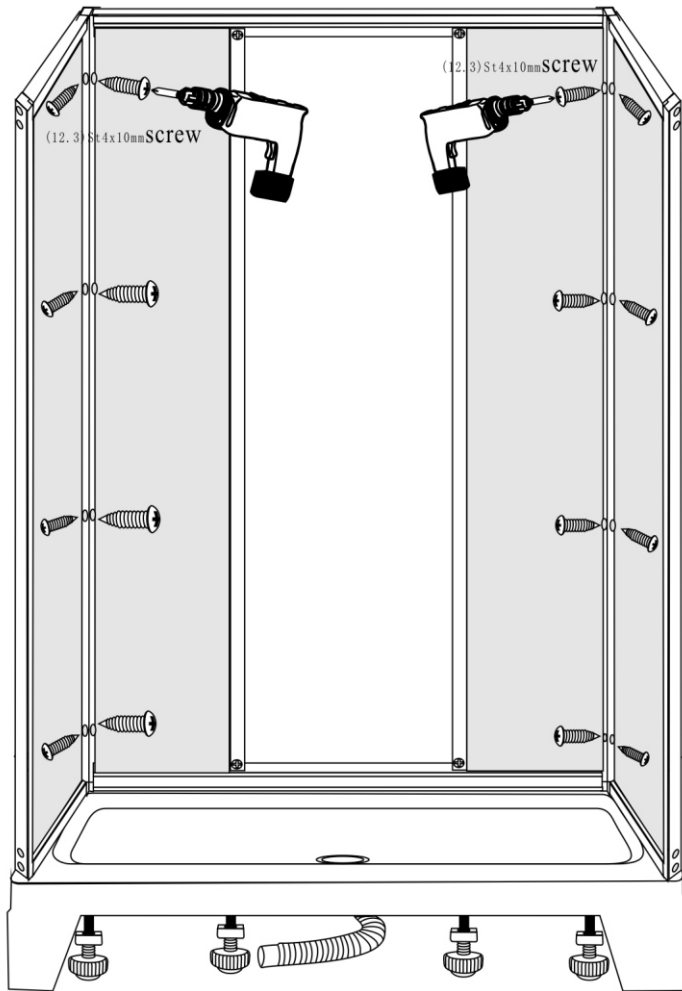

(12)

## 4. Installation Procedure

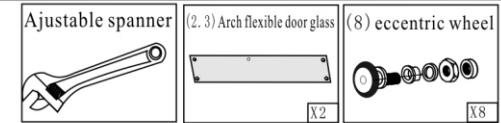

Put the roller(8) into glass door holes, and adjust the roller screw, then hang the door into up rails. Then fix all of roller, to make sure the door move smoothly.

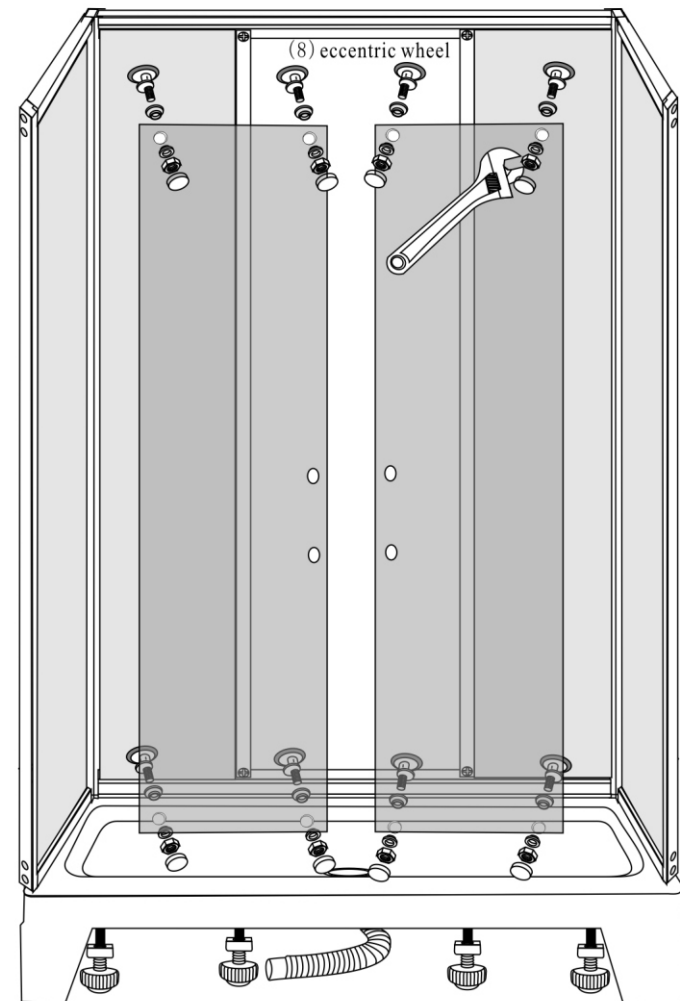

(13)

## 4. Installation Procedure

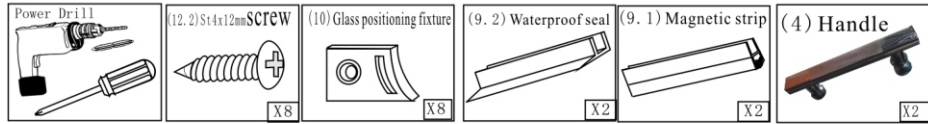

Fit the handle into flexible door, fix rubber position (10) by screws (12.2). Fit the magnetic seal and waterproof belt.

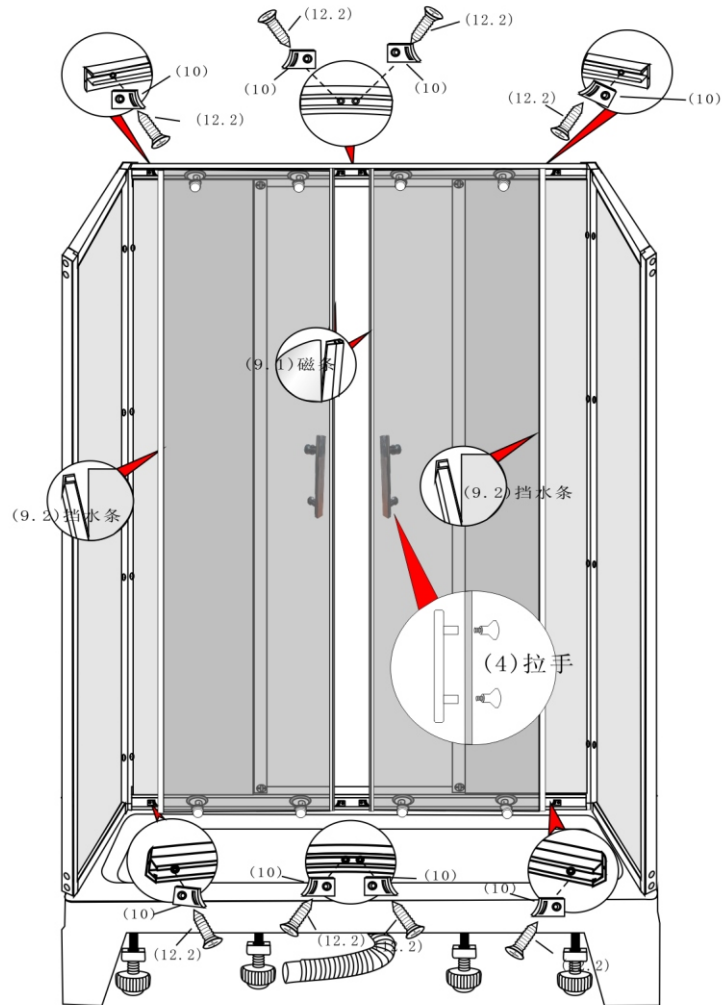

(14)

## 4. Installation Procedure

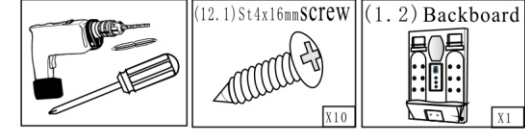

Connect the glass room and back board, by screws (12.1)

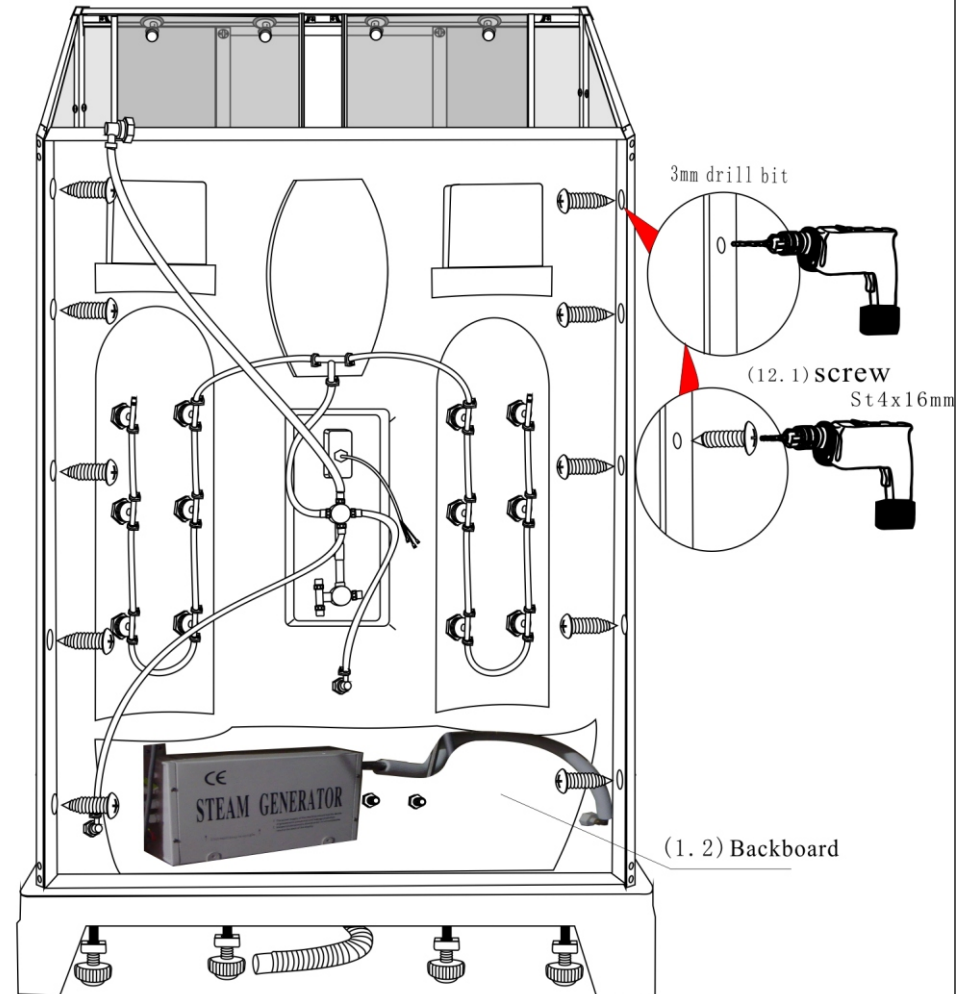

(15)

## 4. Installation Procedure

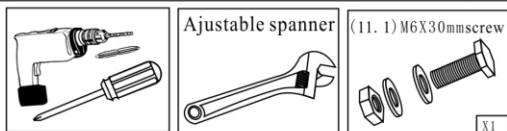

Put the glass room with back board onto the tub,make it suible with tub margin,then fix tub and back board by screw(11)

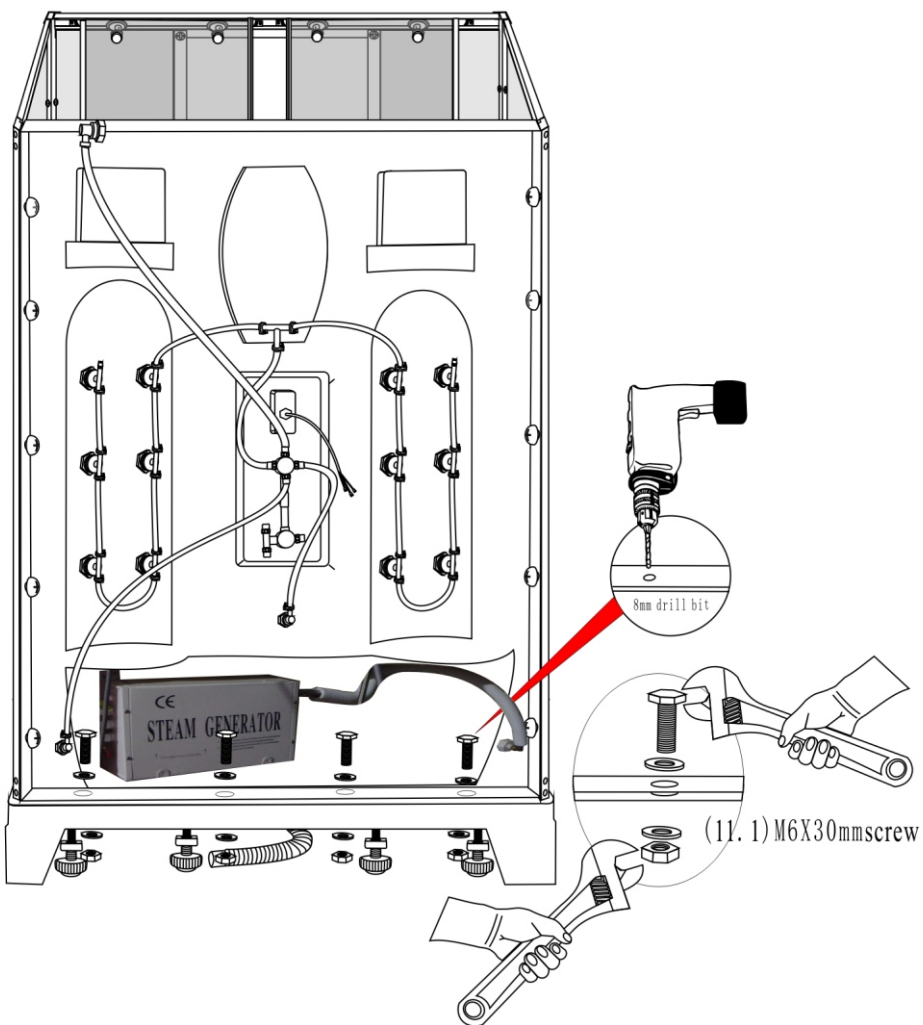

(16)

## 4. Installation Procedure

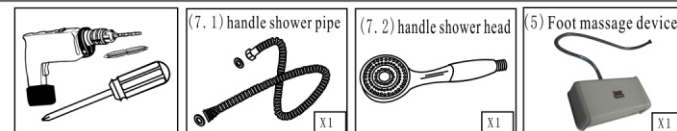

Fit foot massage device,handle shower on the back board

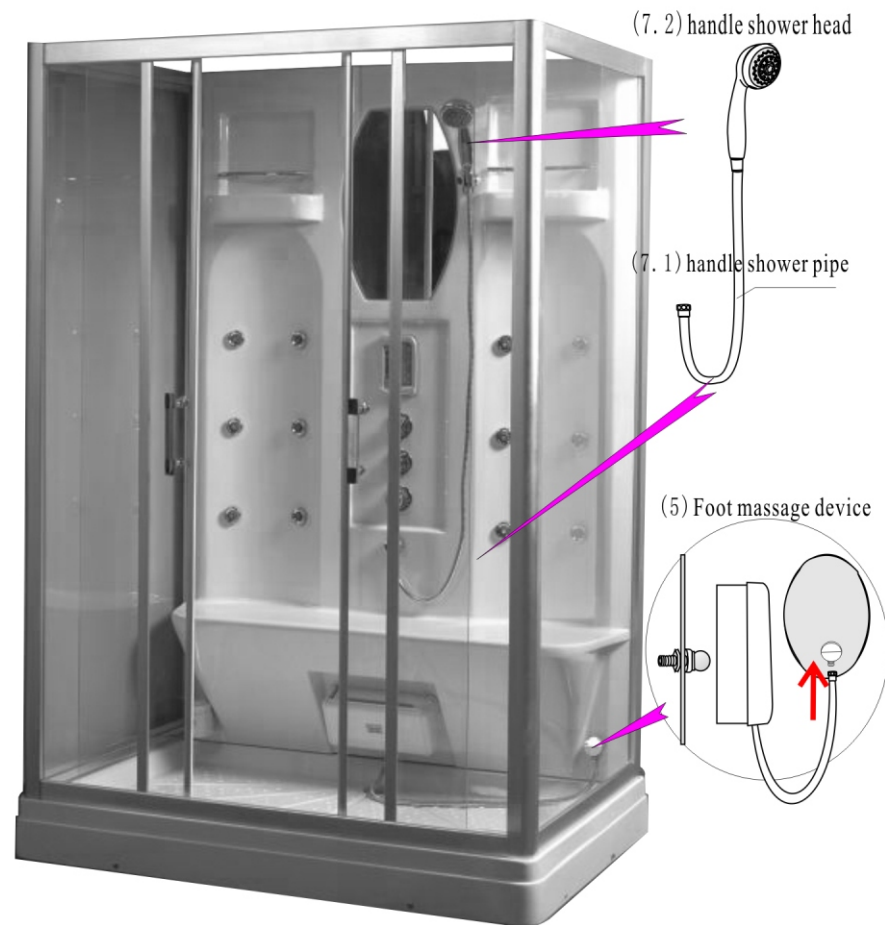

(17)

## 4. Installation Procedure

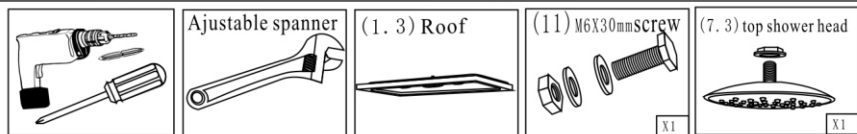

Put the top cover (7.3) onto the glass room, then fix it by screws (11)

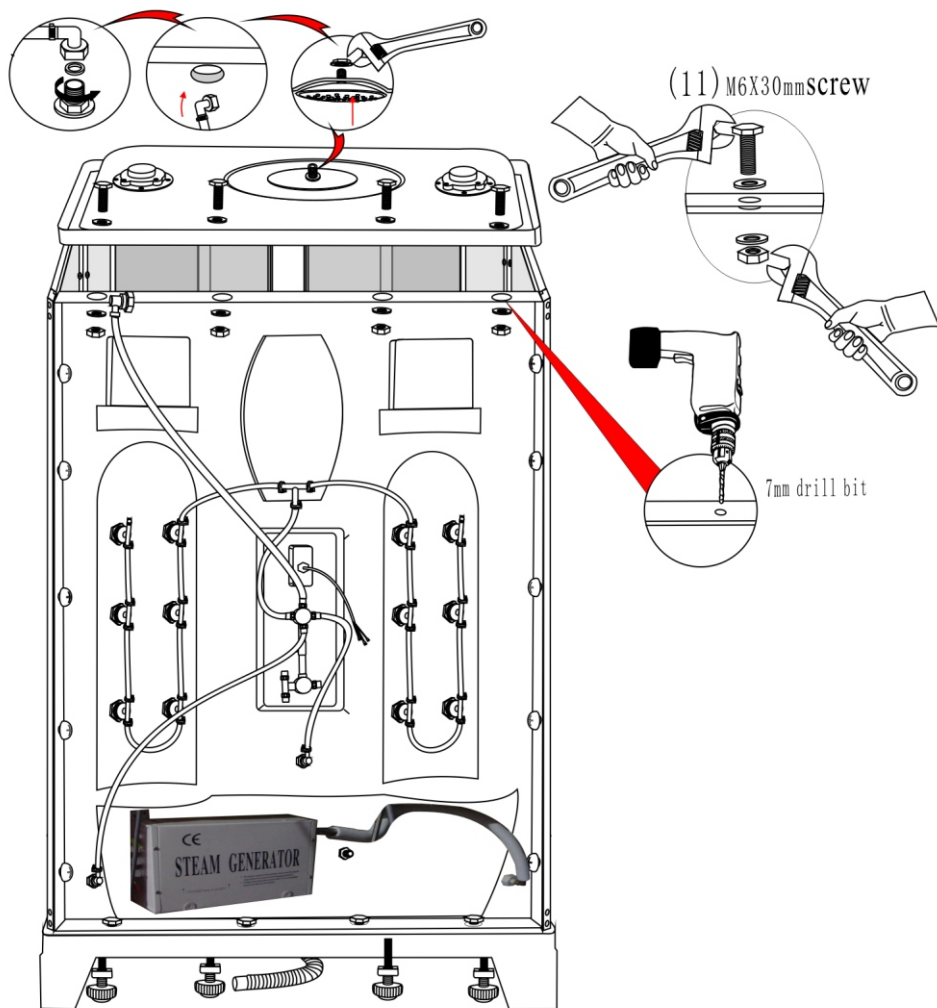

(18)

## 4. Installation Procedure

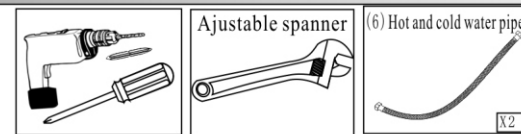

Connect the hot & cold water with inlet, connect the wires as the label, and power on.

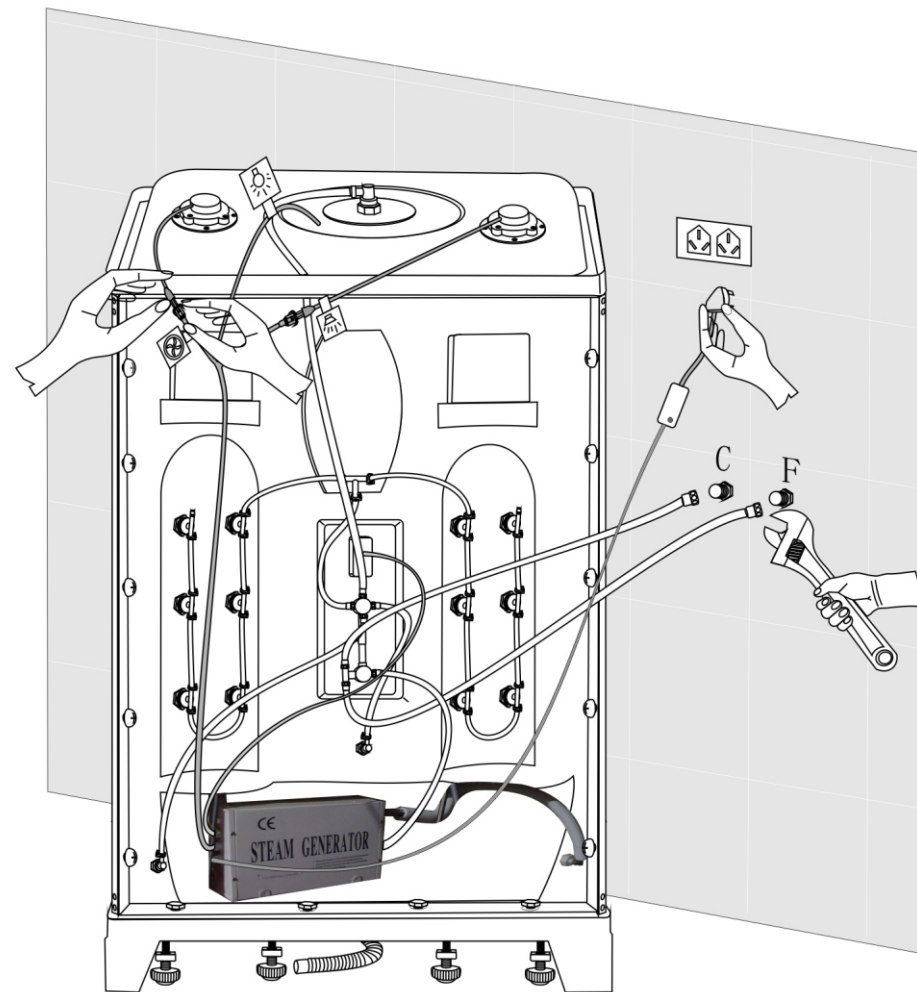

(19)

## 5 Electric appliance instruction

The power outlet using for this steam generator must have a earthed cable and an electric shock protection, and make sure them is availability.

The personnel who install this steam generator must be qualified professional.

AC Supply Voltage: 220V—240V

Water Supply: 0.1-0.4Mpa .

The AC supply using for steam house must be separateness, the cross-section of the power cable must exceed 2.5mm, and with a separate power switch.



Must turn off the power supply after finish using the steam generator

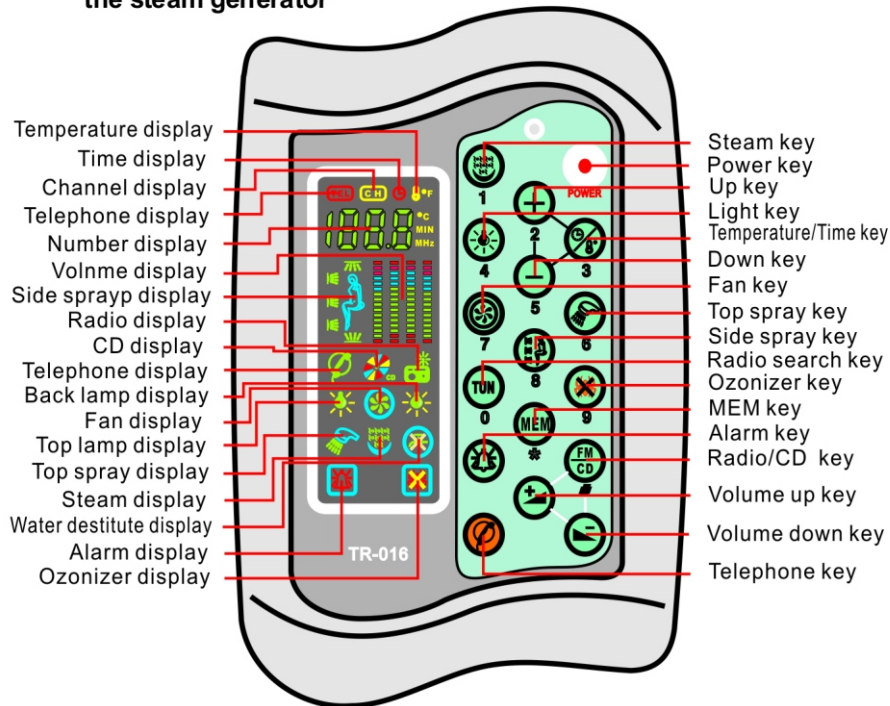





Must cut off the water supply after finish using the steam generator







(20)

## 5 Electric appliance instruction



1、 Please open the water supply valve before you push  'POWER' key to turn on the power. After you push  'POWER' key, the VFD screen will be light, and the steam generator is ready for working , the window of temperature display the currently temperature.

2、 Temperature /Time setting: Push  'TEMPERATURE/TIME' key on the panel once , the temperature icon  will flash, and the predestine temperature is display. You can push  'UP' key or  'DOWN' key to setting the predestine temperature. The predestine temperature limit to :20~ 60°C . Push the  'UP' key or  'DOWN' key after 3 seconds, the temperature continuously up or down. After set the temperature your need, the user-defined temperature be stored in computer REM automatically and the temperature window display the current temperature of bathroom. The steam generator will stop working when the temperature of bathroom is higher than or equal to the user-defined temperature for 30 seconds later, the steam generator will work again. The default temperature is 45°C.

Push  'TEMPERATURE/TIME' key on the panel second, the time icon  will display, and the predestine time is display. you can push  'UP' key or  'DOWN' key to setting the predestine time., the time step two minute for every push, the time limit to: 0 ~60 min .When the time is equal to '00' , the steam generator stop working ,if you need steam work continue, you must reset time again and push  'STEAM' key . As if you need steam generator working without time limit, set time to '00' directly . On operating, you can reset time at anytime.

(21)

## 5 Electric appliance instruction

1、 Be sure water supply is appropriate, then push  'STEAM' key, the steam icon light, the steam spray out after 3 minute. If the water is destitute, the water destitute icon flash and the steam icon only display  , the steam generator stop working impermanent still the water supply is appropriate. If the water is destitute, please find out the trouble of water supply before using steam generator.



On operating, you can push  'STEAM' key again to stop the steam generator working.



2、 Push  'FAN' key, fan icon light, the fan working, you can push 'FAN' key again to stop fan working .

3、 Push  'Light' key, the system can sequential transform the states of top lamp working, two lamp working, back lamp working and all off.

4、 Push  'TOP SPRAY' key, the system can sequential transform the states of top spray, bottom spray and all off.

5、 Push  'SIDE SPRAY' key, the system can sequential transform the states of up spray, middle spray and all off.



6、 Push  'RADIO/CD' key on the panel once, radio icon light, the radio working. Push  'RADIO/CD' key again, radio icon dark, radio turn off, CD icon light, the CD working, push  'RADIO/CD' key again, CD icon dark, CD turn off .



On radio: ( Frequency range : FM87.5 ~ 108 MHz ) push  'RADIO SEARCH' key on the panel once ,the number window show the current frequency, push  'RADIO SEARCH' key on the panel again to be up station searching by single step. Push the key for half second can be automatically station searching.



When the station is searched, push the 'MEM' key for 2 seconds, the current



## 5 Electric appliance instruction



upward with the frequency scale of 1-10.



9、 When have a telephone calling, the telephone buzzer ring, then push  'TELEPHONE' key, telephone icon light, the telephone working and cut off the Radio or CD automatically .Push  'TELEPHONE' key again, telephone icon dark, telephone turn off.

Push  'TELEPHONE' key without telephone call in, changing to the dialing state. The complex key is as the number key. The original function is screened, the VFD screen showing the dialing number, Push  'TELEPHONE' key again to stop telephone.

10、 Volume setting : Push  'VOLUME UP' or  'VOLUME DOWN' key to set up volume, push the key after 3 seconds later, the volume continuously up or down..

11、 When the other functions (except light functions) turn off, push  'OZONIZER' key, the ozonizer working, you can push  'OZONIZER' key again to stop ozonizer working .

12、 When the danger state happened ,push  'ALARM' key, the alarm icon light, the speaker will make the alarm, other functions will be closed except light. Only push  'POWER' key to stop the alarm.

13、 Finish washing, push  'POWER' key to turn off the steam generator. At this time, the VFD screen display count down for 60 second, the steam generator automatic drain, automatic turn off the Steam, Fan, spray, Light, Radio, CD and Telephone . The steam generator will standing again after 60 second. You can push  'POWER' key to restart the steam generator.

14、 Finish using the steam generator, please turn off the power and cut off the water supply.

## 5 Electric appliance instruction

### ELECTRICAL SPECIFICATIONS :

Supply Power	Alternating current 220V-240V
Power Frequency	50Hz/60Hz
Control Voltage	Direct current 12V
Limit Power	3KW
Light Voltage	Alternating Current 12V
Fan Voltage	Direct current 12V
Radio Output Power	5W

### WATER SUPPLY INSTALL:

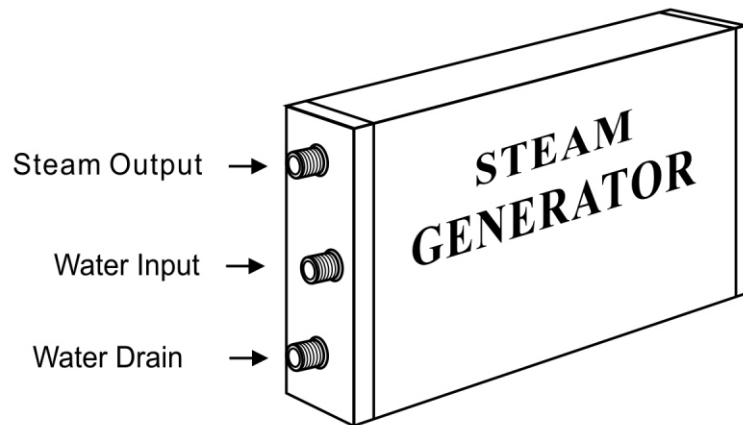

(24)

## 6: Notes

1. It is unadvisable to take a shower after drunk.
2. It is unadvisable to have a shower immediately after acute sports.
3. Please avoid bath or shower in morning.
4. Keep the temperature of dressing room near to the bathroom's
5. If you feel uncomfortable while having a shower, you should go out of the shower room as soon as possible.
6. The time of shower is advisable to be between 15 minutes and 20 minutes, no longer.
7. Drink water to supplement moisture after shower or bathing.
8. People who suffer from heart disease, high blood pressure, diabetes or who feel unwell or pregnant woman are unadvisable to have bathing, massage or shower.

## 7: Delivery and storage notice

1. It is prohibited to store organic solvent together, such as formic acid and methanol.
2. Handle with care if it need transport. Heavy stress, mechanical impact and sharp pounding is prohibited.
3. It should keep it dry and airy and make sure there is no etchant gas.

(25)

## 8, Trouble shootings

Troble	Cause	Remedy
No power	1.Electric power don't connect well,leak swtich is cut off.	Access to power
	2.Fuse wire is broken,switch of control panel is failure.	Maintain or replace
	3.GFCI is out of work	Check GFCI
No head shower	1.water pressure is abnormal	Check water pressure
	2.Cold and hot water switch is closed.	Turn on the cold and hot water switch
	3.chocking nozzle	Clean
Water pipe leakage	1.Seal ring damaged	Replace seal ring
	2.Tie in don't connect well	Connect it again
No radio	1.Connecting wire is cut	Make connection
	2.Loudspeaker is broken	Replace a new one
Phone unuable	1.Telephone wire don't connect well	To make contact telephone line
	2.Control panel is broken	Maintain or replace
No light	1. Bulb is broken,ballast is broken	Replace
	2.Break of ballast	To make contact
	3.Control panel is broken	Maintain or replace
No exhaust	1.Fan is broken	Replace
	2.Tie-in is not connect well	To make contact
	3.Control panel is broken	Maintain or replace

If complete shower room cant work normally, please check it as compare above then obstacle avoidance.

If customers cant make sure the cause of obstacle or lack of ability mantianance.Please contact distributer.