

9002



SIZE: 130X85X215cm

(1)

## Cautions in Installation and Using





Thanks for selecting our shower room series. To guarantee safe and normal operation as well as prolong service lifetime. Pls read Instruction carefully before installation.

Note: Constar is dedicated to improving products quality, find something new in what is old, we would if there is difference in the Instruction until further notice. Any discomfort, we ask your pardon.



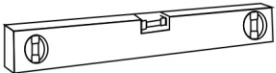

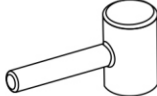
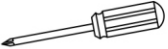

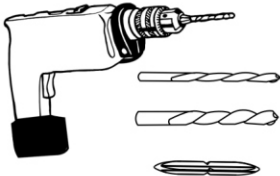



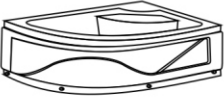

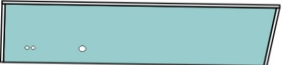
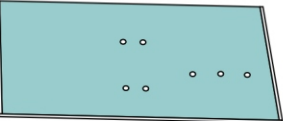
### Directory

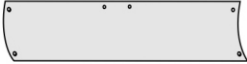
1. Tool contents	-----	3
2. Accessory list	-----	4-6
3. Pipe and drain installation drawing	-----	7
4. Installation Procedure	-----	8-24
5. Electric appliance instruction	-----	19-23
6. Notes	-----	24
7. Delivery and storage notice	-----	24
8. Trouble shootings	-----	25

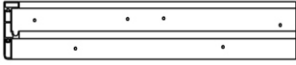
## 1. self-provide tool



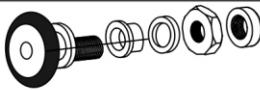





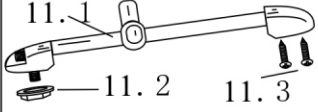
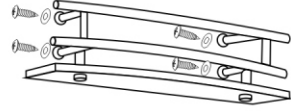

Name	Tool
Track level bar	
Tape measure	
Ajustable spanner	
Rubber hammer	
Phillips srewdriver	
Scissors	
Glass cement	
electric drill	
3mm aiguille	
6mm aiguille	
tap drill	

## 2.Partial accessory list

Item	Name	Accessory	Quantity
1	(1) Tub		1
2	(2) Middle backboard		1
3	(3. 1) Middle backboard		1
	(3. 2) Right backboard		1
	(3. 3) Arch fixed door glass		2
	(3. 4) Arch flexible door glass		2
4	(4) Roof		1
5	(5. 1) Upper rail		1
	(5. 2) Bottom rail		1
	(5. 3) Side upright column		2
6	(6) Knob		2
7	(7) Eccenter		8
8	(8. 1) Glass positioning fixture		8
	(8. 2) Glass keep plate		4

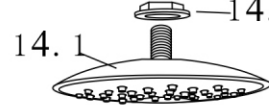
(4)

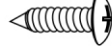
## 2.Partial accessory list

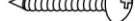
Item	Name	Accessory	Quantity
9	(9) Foot massager		1
10	(10. 1) Handshower		1
	(10. 2) hand shower tube		1
11	(11) Lifting rod		1
12	(12. 1) Shelf		2
	(12. 2) Towel bar		1
13	(13. 1) Magnetic strip		1
	(13. 2) Waterproof belt		2
	(13. 3) U style thong		4
14	(14)Top shower		1
15	(15) Cold and hot water hose		2
16	(16. 1) St 4*16mm self tapping screw		10
	(16. 2) St 4*10mm self tapping screw		22
	(16. 3) St 4*10mm self tapping screw		8

(5)

### 3. Pipe and drain installation drawing

Dimension: 130\*85\*215cm

C=Cold water inlet

H=Hot water inlet

D=Drain



(6)

### 4. Installation Procedure

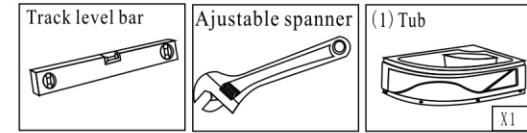

Put the track level bar on the tub, adjust foot screws by adjustable spanner, to maintain the level state.

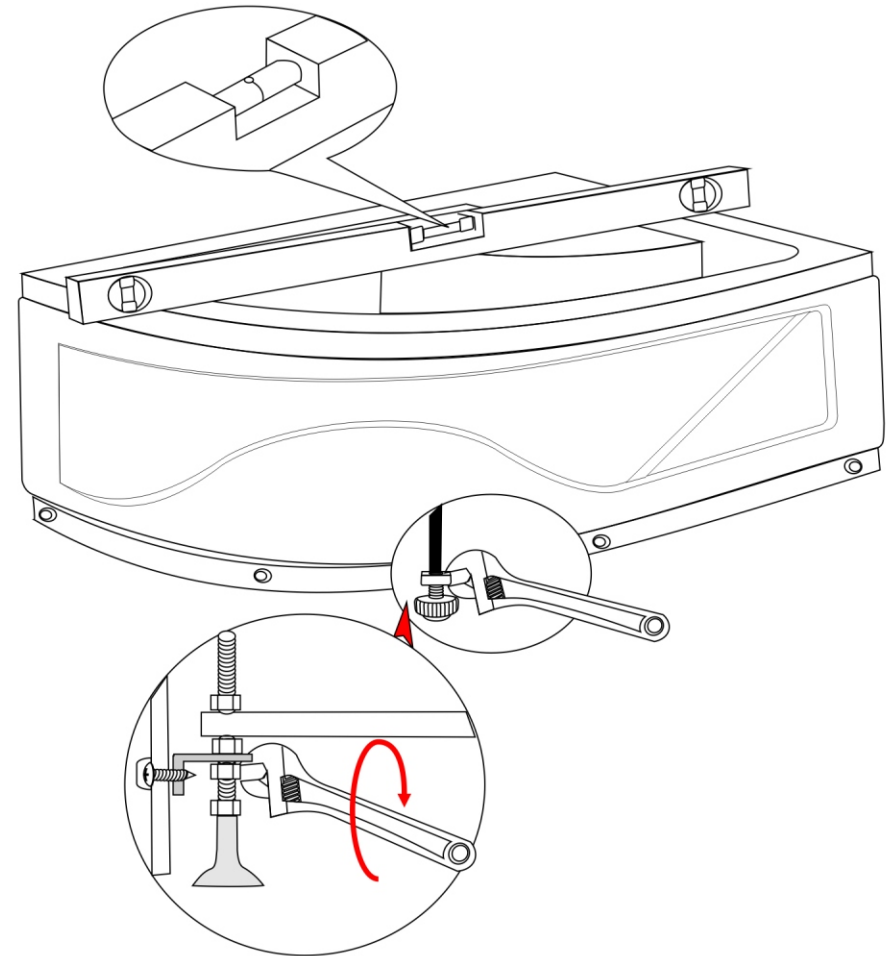

(7)

## 4. Installation Procedure

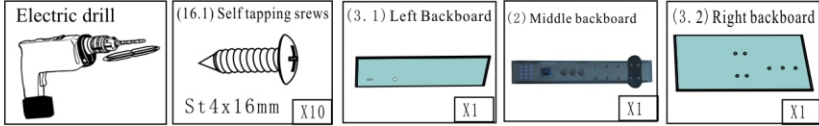

To align three pieces of backboard, dig holes with 3mm drill bit, tighten with (16.1) Self tapping screws. hypodispersion

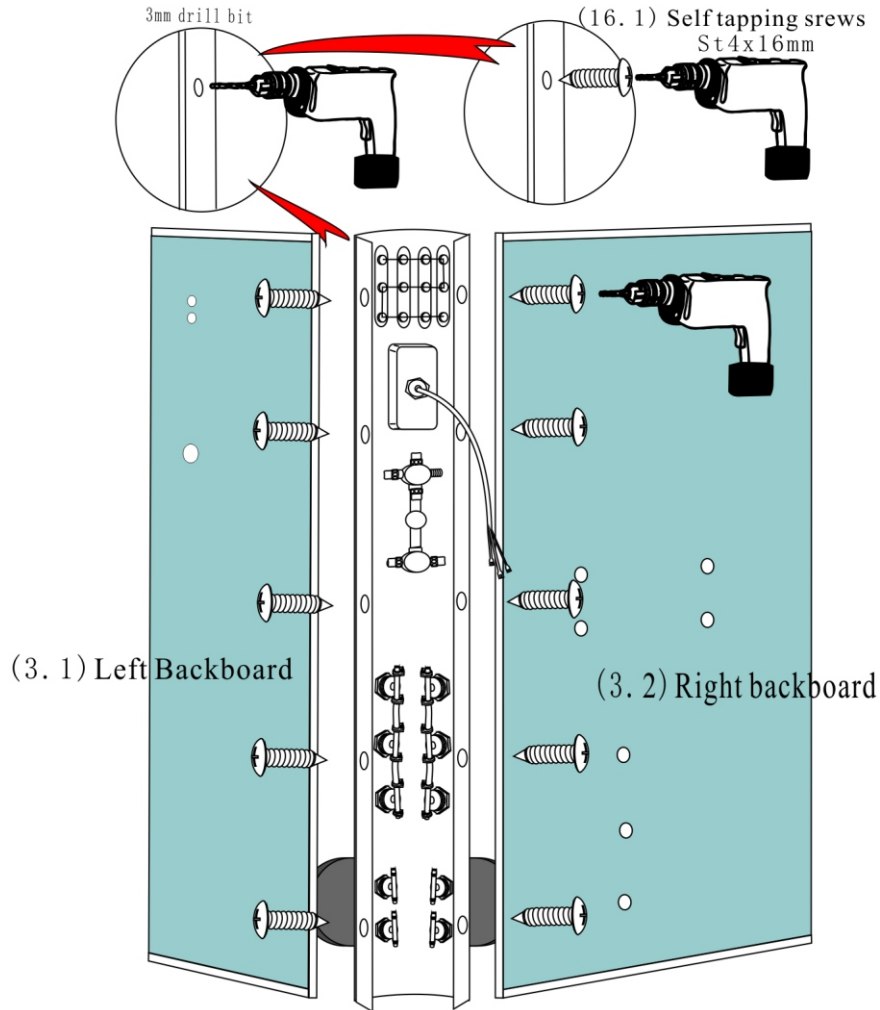

(8)

## 4. Installation Procedure

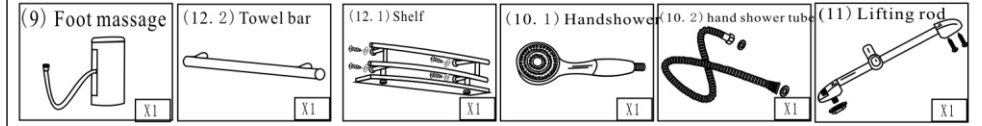

Fix relevant accessory to the backboard, connect pipes accordingly.

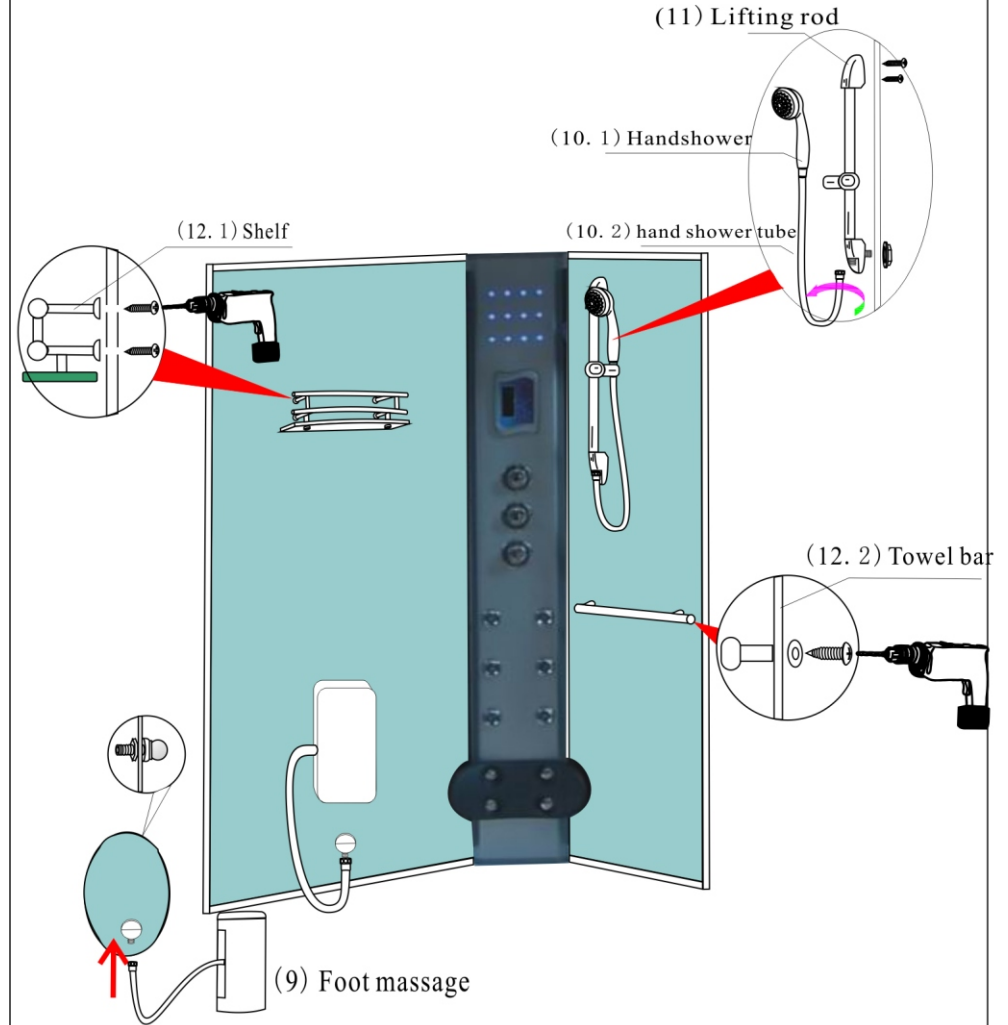

(9)

## 4. Installation Procedure

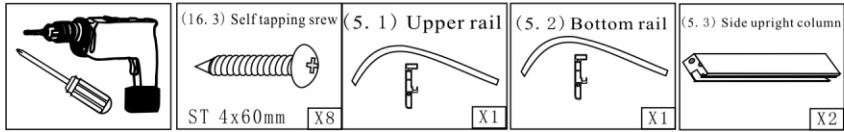

Connct rails with side upright column by St4\*60mm screws.

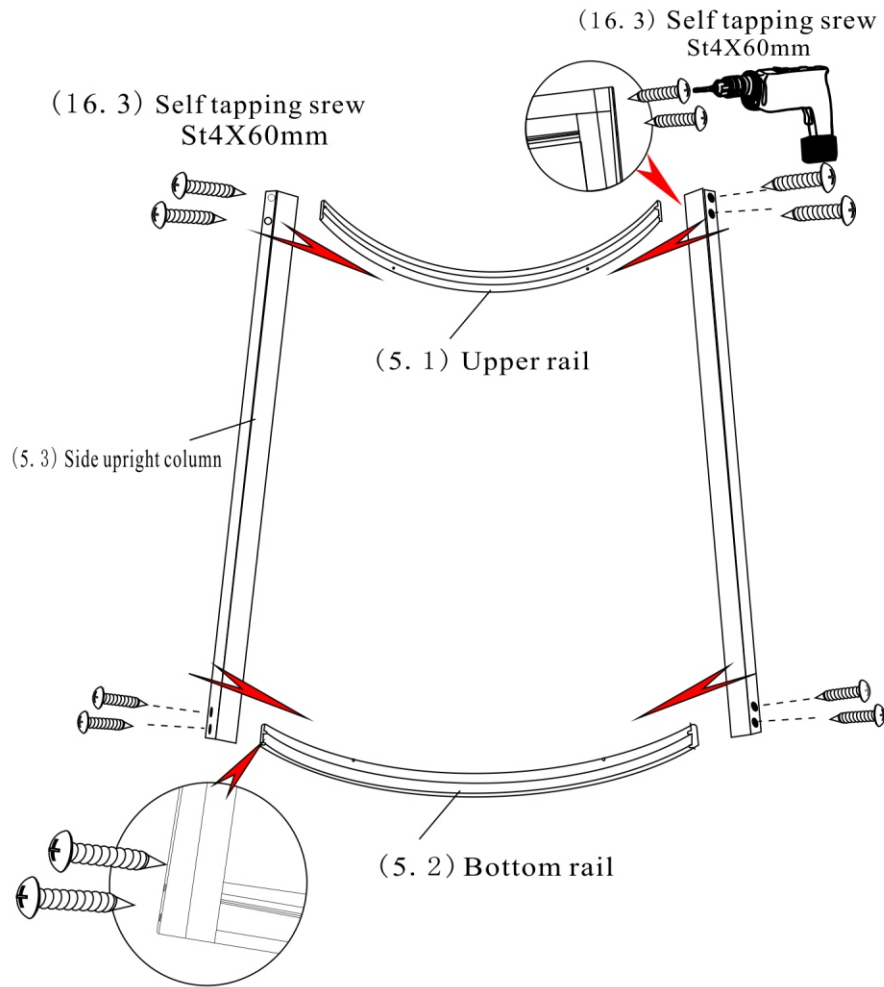

(10)

## 4. Installation Procedure

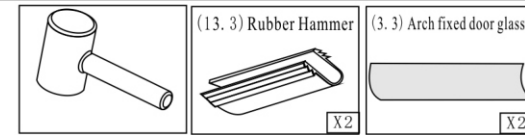

Insert U style thong to arch fixed door glass, put on the rails and knock it to socket of side upright column with rubber hammer.

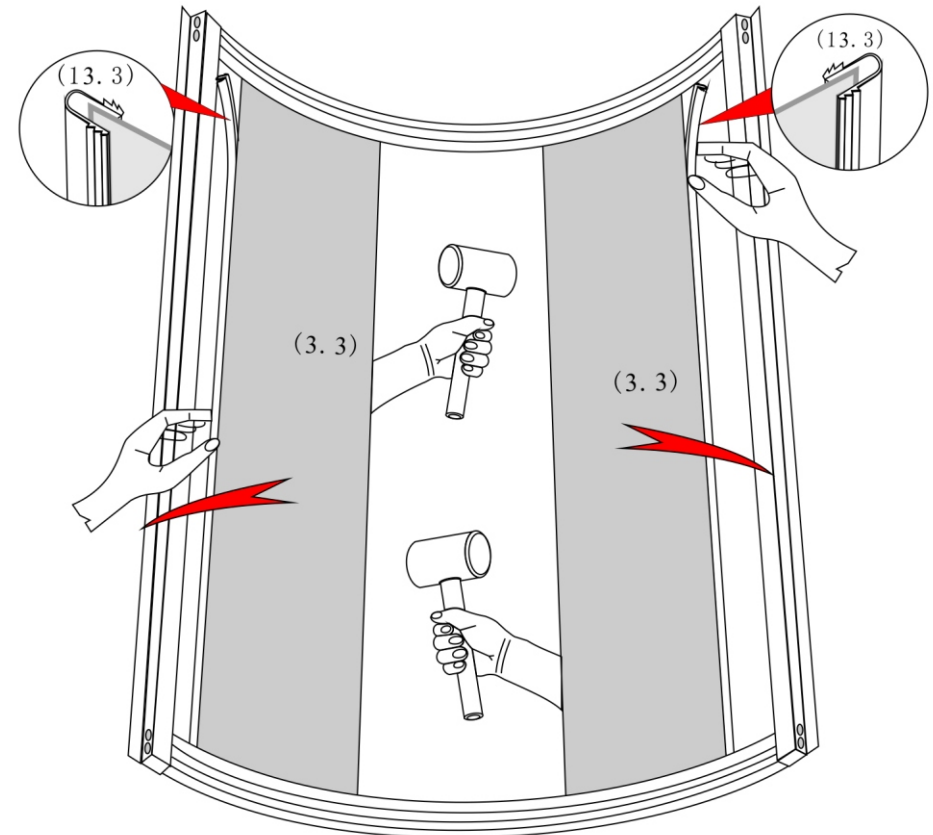

(11)

## 4. Installation Procedure

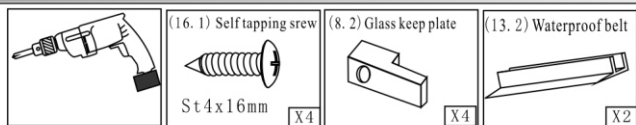

Install fixed door with self tapping screw and glass keep plate.  
Then insert waterproof belt.

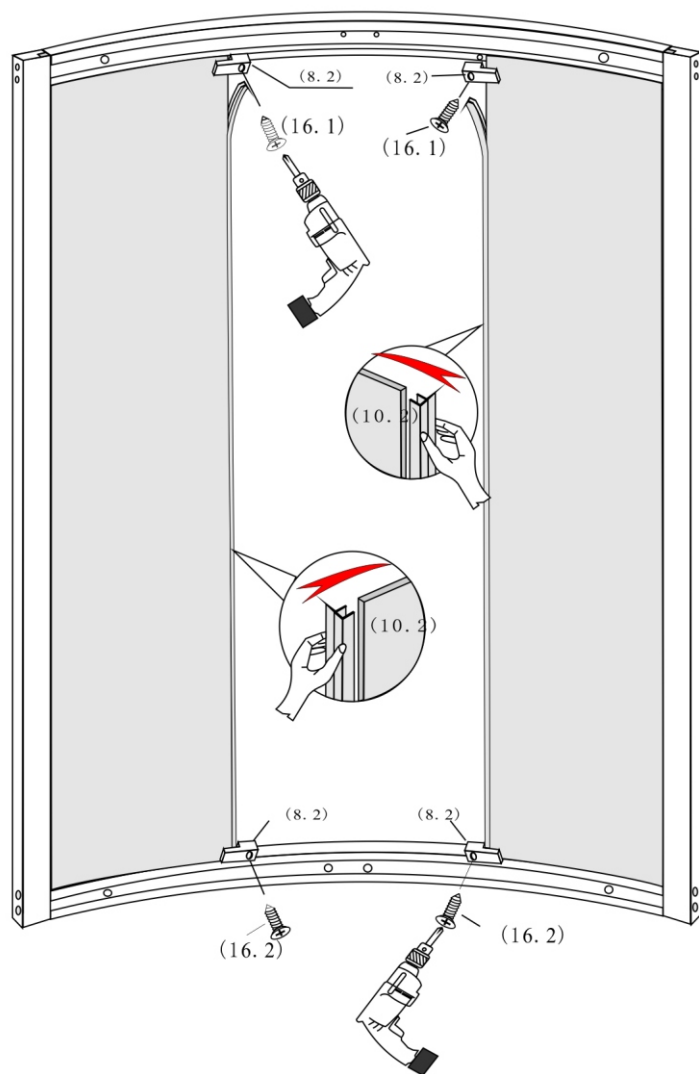

(12)

## 4. Installation Procedure

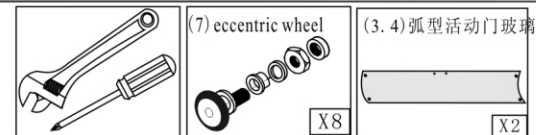

Put eccentric wheels to the glass holes,



(13)

## 4. Installation Procedure

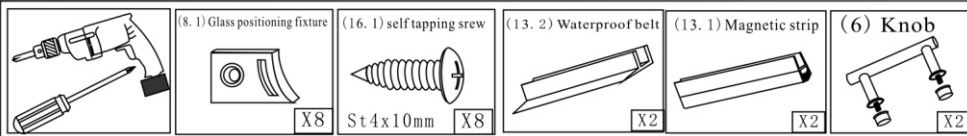

Put knob into movable door's hole, tighten with screws. Fix glass positioning fixture with self tapping screw, then insert waterproof belt and magnetic belt.

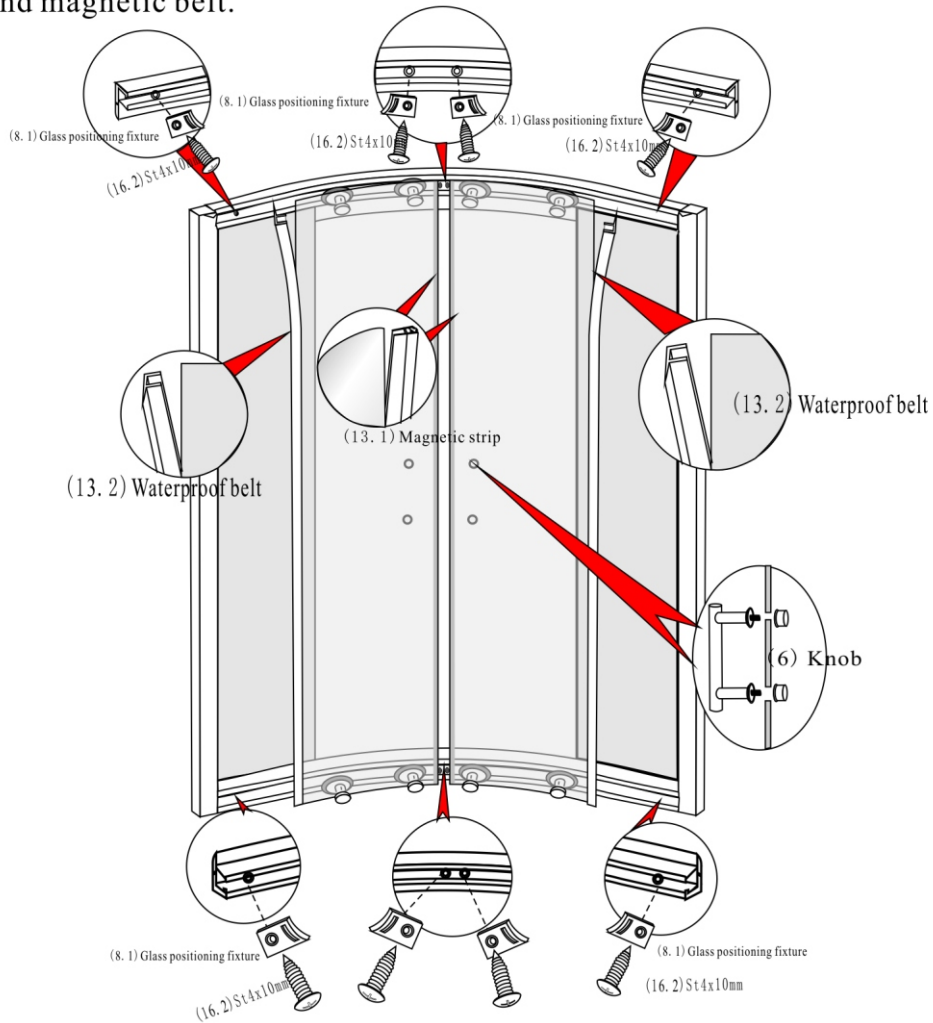

(14)

## 4. Installation Procedure

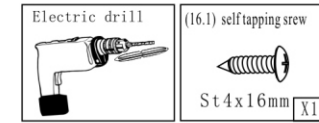

To align backboard and glass room, then bore holes with 3 mm diameter drill bit, tighten with (12.3) Self tapping screws.

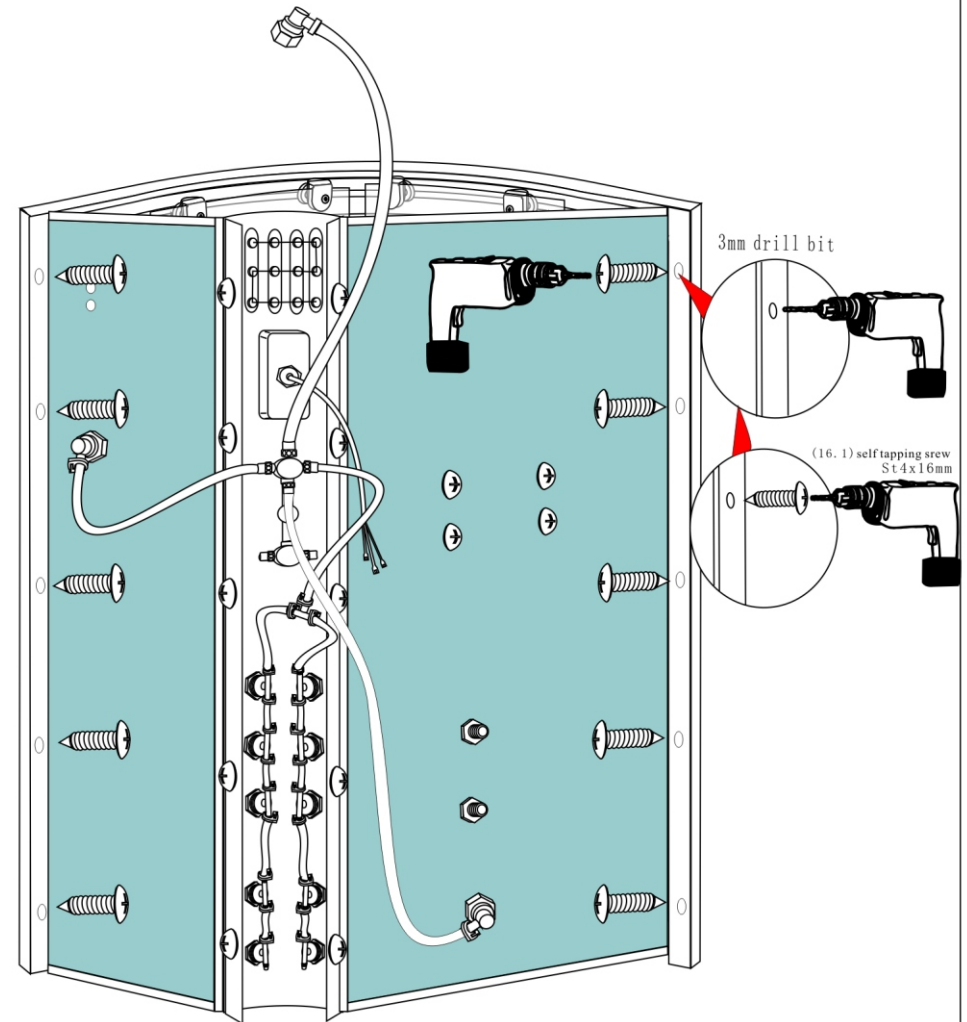

(15)



## 4. Installation Procedure



Carry backboard and glass room on the tub, adjust place, then use 3 mm drill to dig holes, tighten with (12.3) self tapping scw.

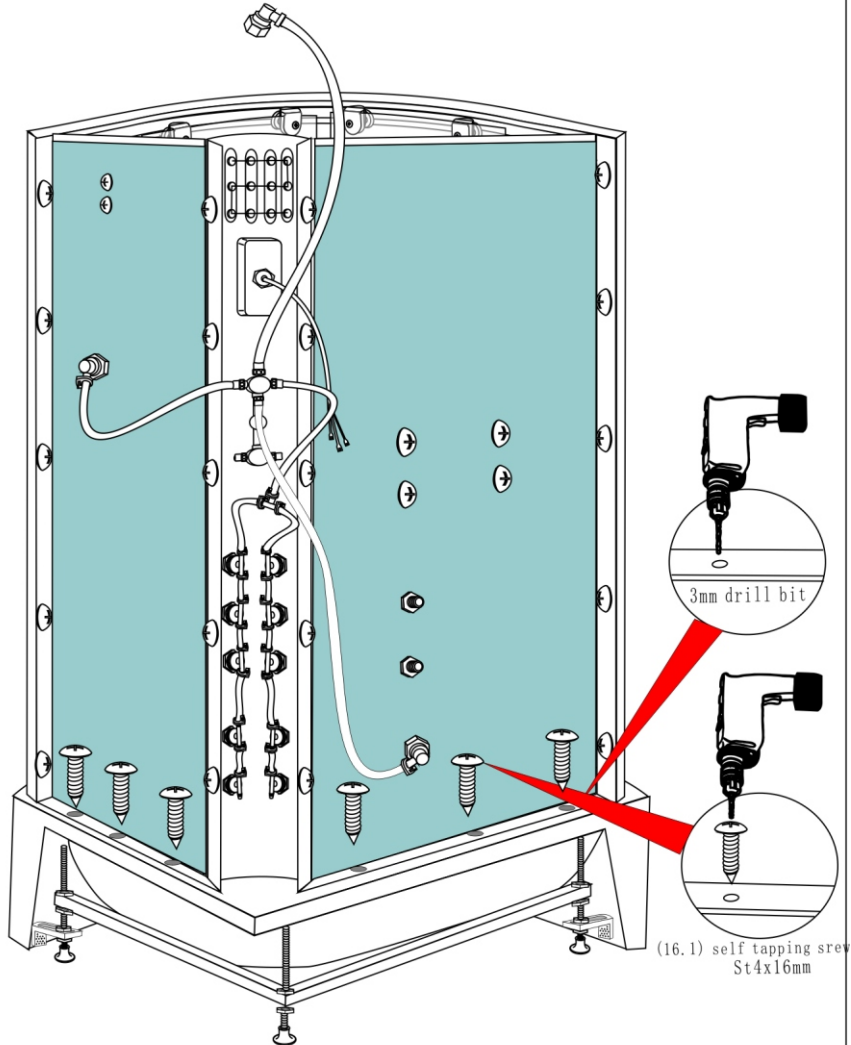

(16)

## 4. Installation Procedure

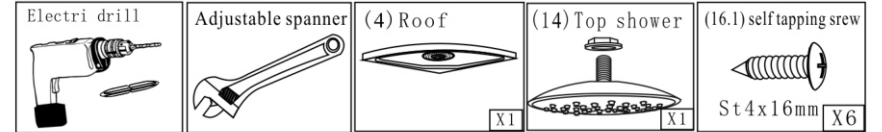

Fix top shower in the roof, then move it to use 3 mm drill

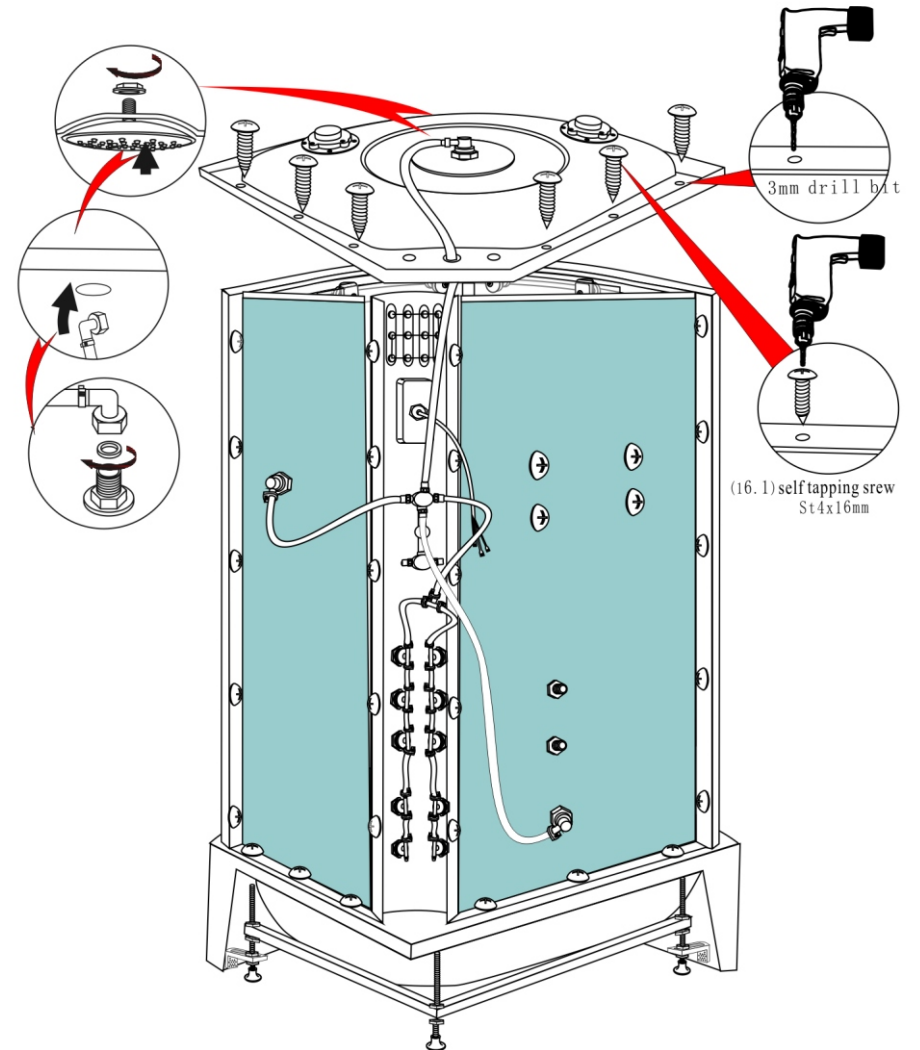

(17)

## 4. Installation Procedure

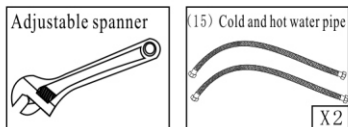

Connect cold and hot water with installed shower room by adjustable spanner, then plug in

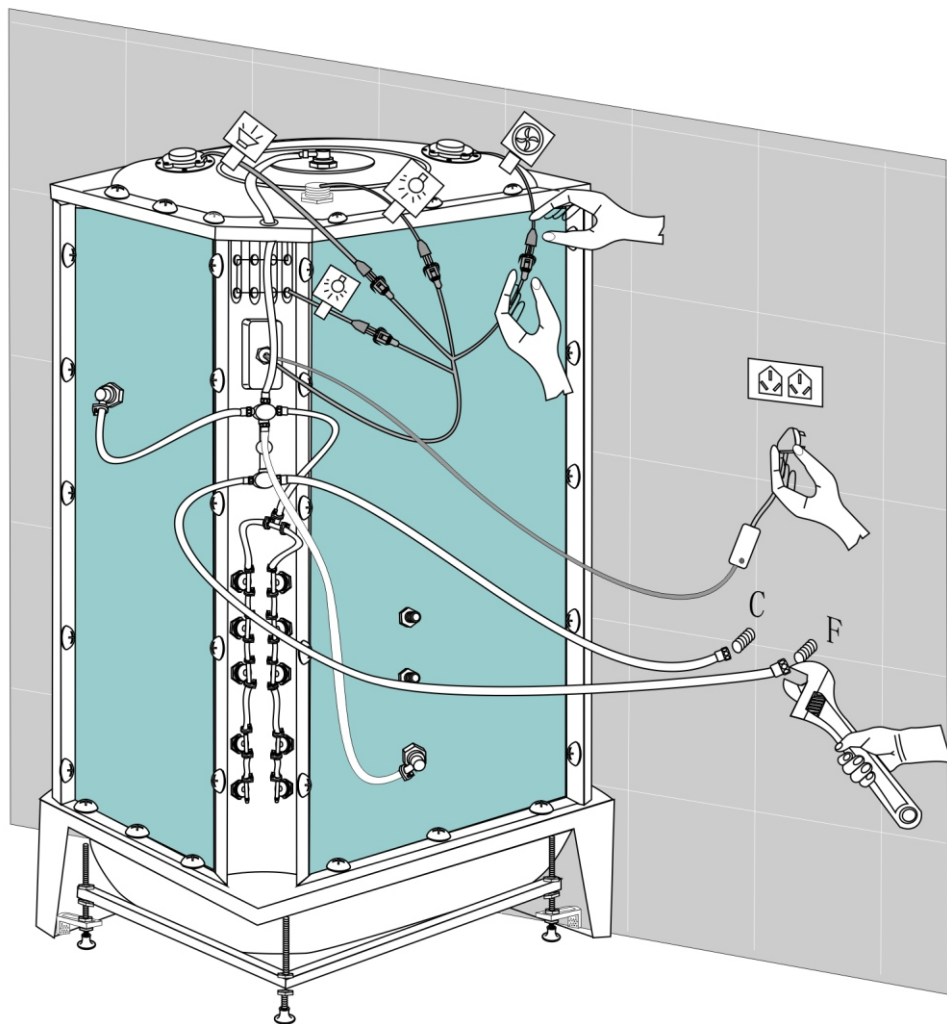

(18)

## 5 Electric appliance instruction

The power outlet using for this steam generator must have a earthed cable and an electric shock protection, and make sure them is availability.

The personnel who install this steam generator must be qualified professional.

AC Supply Voltage: 220V—240V

Water Supply: 0.1-0.4Mpa .

The AC supply using for steam house must be separateness, the cross-section of the power cable must exceed 2.5mm, and with a separate power switch.

Must turn off the power supply after finish using the steam generator

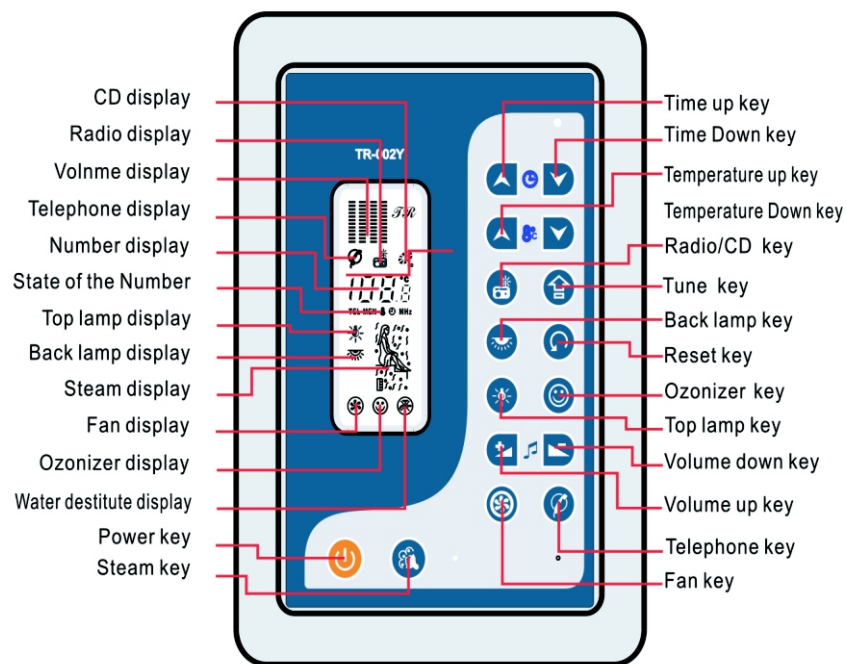

Must cut off the water supply after finish using the steam generator















(19)

## 5 Electric appliance instruction



### Steam generator Operation manual

1、 Please open the water supply valve before you push  'POWER' key to turn on the power. After you push  'POWER' key, the VFD screen will be light, and the steam generator is ready for working , the window of temperature display the currently temperature.



2、 Temperature setting: Push  'TEMPERATURE UP' key or  'TEMPERATURE DOWN' key on the panel , the temperature icon  will flash, and the predestine temperature is display. You can push  'TEMPERATURE UP' key or  'TEMPERATURE DOWN' key to setting the predestine temperature. The predestine temperature limit to :20~ 60℃ . Push the  'TEMPERATURE UP' key or  'TEMPERATURE DOWN' key after 3 seconds, the temperature continuously up. After set the temperature your need, the user-defined temperature be stored in computer REM automatically and the temperature window display the current temperature of bathroom. The steam generator will stop working when the temperature of bathroom is higher than or equal to the user-defined temperature for 30 seconds later, the steam generator will work again. The default temperature is 45℃.



3、 Time setting : Push  'TIME UP' key or  'TIME DOWN' key on the panel, the time icon  will display, and the predestine time is display. you can push  'TIME UP' key or  'TIME DOWN' key to setting the predestine time., the time step two minute for every push, the time limit to: 0 ~60 min .When the time is equal to '00' , the steam generator stop working ,if you need steam work continue, you must reset time again and push  'STEAM' key . As if you need steam generator working without time limit, set time to '00' directly .



## 5 Electric appliance instruction



4、 Be sure water supply is appropriate, then push  'STEAM' key, the steam icon light, the steam spray out after 3 minute. If the water is destitute, the water destitute icon flash and the steam icon only display  , the steam generator stop working impermanent still the water supply is appropriate. If the water is destitute, please find out the trouble of water supply before using steam generator. On operating, you can push  'STEAM' key again to stop the steam generator working.

5、 Push  'FAN' key, fan icon light, the fan working, you can push 'FAN' key again to stop fan working .

6、 Push  'TOP LAMP' key, top lamp icon light, the top lamp working, you can push  'TOP LAMP' key again to stop top lamp working .



7、 Push  'BACK LAMP' key, back lamp icon light, the back lamp working, you can push  'BACK LAMP' key again to stop back lamp working .



8、 Push  'RADIO/CD' key on the panel, radio icon light, the radio working. Push  'RADIO/CD' key again, radio icon dark, radio turn off ,



On radio: ( Frequency range : FM87.5 ~ 108 MHz ) push  "TUNE "key , the radio searching broadcast from 87.5MHz up to 108MHz automatically .When get a broadcast, the radio can self-lock the broadcast, push "TUNE "key again the radio automatic search for next broadcast .As if frequency arrive 108MHz, push  "RESET "key to reset the frequency to 87.5MHz, then push  "TUNE "key again to search broadcast automatically .



## 5 Electric appliance instruction



upward with the frequency scale of 1.10



9、 Push  'RADIO/CD' key, CD icon light, the CD working, you can push  'RADIO/CD' key again to stop CD working .

10、 When have a telephone calling, the telephone buzzer ring, then push  'TELEPHONE' key, telephone icon light, the telephone working and cut off the Radio or CD automatically .Push  'TELEPHONE' key again, telephone icon dark, telephone turn off.

Push  'TELEPHONE' key without telephone call in, changing to the dialing state. The complex key is as the number key. The original function is screened, the LCD screen showing the dialing number, Push  'TELEPHONE' key again to stop telephone.

11、 Volume setting : Push  'VOLUME UP' or  'VOLUME DOWN' key to set up volume, push the key after 3 seconds later, the volume continuously up or down..

12、 When the other functions (except light functions) turn off , push  'O3' key on the panel, The O3 icon  display and the Ozonizer working, push  'O3' key again, O3 icon dark and ozonizer stop working .

13、 Finish washing, push  'POWER' key to turn off the steam generator. At this time, the LCD screen display count down for 60 second, the steam generator automatic drain, automatic turn off the Steam, Fan, spray, Light, Radio, CD and Telephone . The steam generator will standing again after 60 second. You can push  'POWER' key to restart the steam generator.

14、 Finish using the steam generator, please turn off the power and cut off the water supply.

## 5 Electric appliance instruction

### ELECTRICAL SPECIFICATIONS :

<b>Supply Power</b>	Alternating current 230V $\pm$ 10% <input type="checkbox"/>
	Alternating current 220V $\pm$ 10% <input type="checkbox"/>
	Alternating current 110V $\pm$ 10% <input type="checkbox"/>
	Alternating current 100V $\pm$ 10% <input type="checkbox"/>
<b>Power Frequency</b>	<b>50 Hz/60 Hz</b>
<b>Control Voltage</b>	<b>DC 12V</b>
<b>Steam generator power</b>	<b>2.5KW--3.0 KW</b>
<b>Light Voltage</b>	<b>AC 12V 20W</b>
<b>Fan Voltage</b>	<b>DC 12V 2W</b>

### WATER SUPPLY INSTALL:

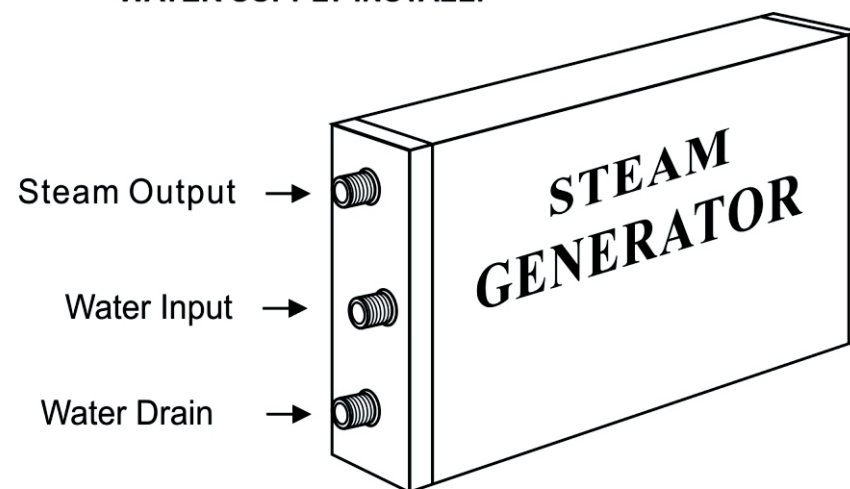

## 6: Notes

1. It is unadvisable to take a shower after drunk.
2. It is unadvisable to have a shower immediately after acute sports.
3. Please avoid bath or shower in morning.
4. Keep the temperature of dressing room near to the bathroom's
5. If you feel uncomfortable while having a shower, you should go out of the shower room as soon as possible.
6. The time of shower is advisable to be between 15 minutes and 20 minutes, no longer.
7. Drink water to supplement moisture after shower or bathing.
8. People who suffer from heart disease, high blood pressure, diabetes or who feel unwell or pregnant woman are unadvisable to have bathing, massage or shower.

## 7: Delivery and storage notice

- 1, It is prohibited to store organic solvent together, such as formic acid and methanol.
2. Handle with care if it need transport. Heavy stress, mechanical impact and sharp pounding is prohibited.
3. It should keep it dry and airy and make sure there is no etchant gas.

## 8, Trouble shootings

Troble	Cause	Remedy
No power	1. Electric power don't connect well, leak switch is cut off.	Access to power
	2. Fuse wire is broken, switch of control panel is failure.	Maintain or replace
	3. GFCI is out of work	Check GFCI
No head shower	1. water pressure is abnormal	Check water pressure
	2. Cold and hot water switch is closed.	Turn on the cold and hot water switch
	3. chocking nozzle	Clean
Water pipe leakage	1. Seal ring damaged	Replace seal ring
	2. Tie in don't connect well	Connect it again
No radio	1. Connecting wire is cut	Make connection
	2. Loudspeaker is broken	Replace a new one
Phone unuable	1. Telephone wire don't connect well	To make contact telephone line
	2. Control panel is broken	Maintain or replace
No light	1. Bulb is broken, ballast is broken	Replace
	2. Break of ballast	To make contact
	3. Control panel is broken	Maintain or replace
No exhaust	1. Fan is broken	Replace
	2. Tie-in is not connect well	To make contact
	3. Control panel is broken	Maintain or replace

If complete shower room cant work normally, please check it as compare above then obstacle avoidance.

If customers cant make sure the cause of obstacle or lack of ability mantianance. Please contact distributor.