

Complete Shower Room Installation Instruction

8253

SIZE:900*900*2250mm



Respected customer

Thanks for selecting our shower room series. To guarantee safe and normal operation as well as prolong service lifetime. Please read Instruction carefully before installation.

Note: We are dedicated to improving products quality, find something new in what is old, if there is difference in the Instruction until further notice. Any inconvenience, beg for your pardon.

Directory

1: Tool contents	2
2: Accessory list	3-4
3: Pipe and drain installation drawing	5
4: Installation Procedure	6-15
5: Notes	16
6: Delivery and storage notices	16
7: clearing of fault	17







7:clearing of fault



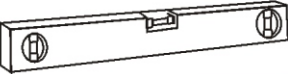

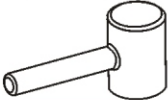



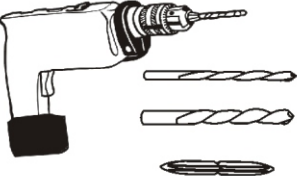

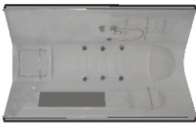
Troble	Cause	Remedy
No power	1.Electric power don't connect well,leak swtich is cut off.	Access to power
	2.Fuse wire is broken,switch of control panel is failure.	Maintain or replace
	3.GFCI is out of work	Check GFCI
No head shower	1. water pressure is abnormal	Check water pressure
	2.Cold and hot water switch is closed.	Turn on the cold and hot water switch
	3.chocking nozzle	Clean
Water pipe leakage	1.Seal ring damaged	Replace seal ring
	2.Tie in don't connect well	Connect it again
No radio	1.Connecting wire is cut	Make connection
	2.Loudspeaker is broken	Replace a new one
Phone unuable	1.Telephone wire don't connect well	To make contact telephone line
	2.Control panel is broken	Maintain or replace
No light	1. Bulb is broken,ballast is broken	Replace
	2.Break of ballast	To make contact
	3.Control panel is broken	Maintain or replace
No exhaust	1.Fan is broken	Replace
	2.Tie-in is not connect well	To make contact
	3.Control panel is broken	Maintain or replace

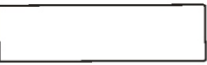
If complete shower room cant work normally, please check it as compare above then obstacle avoidance.

If customers cant make sure the cause of obstacle or lack of ability mantianance.Please contact distributor.

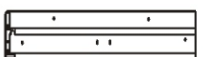
1:Self-prepared tools

Name	Tool
Track level bar	
tape measure	
Ajustable spanner	
Rubber hammer	
Phillips srewdriver	
Scissors	
Glass cement	
electric drill	
3mm aiguille	
6mm aiguille	
"+" shaped aiguille	

2:Accessory list			
Items	Name	Accessory	Quantity
1	(1.1)Tub		1
	(1.2)backboard		1
	(1.3)roof		1
2	(2.1)fixed door		2
	(2.2)Movable door		2
3	(3.1)side upright column		2
	(3.2)Upper rail		1
	(3.3)Bottom rail		1
4	(4)wheel		8
5	(5.1)Handle		2
	(5.2)top shower		1
6	(6)Glass holder		4

(3)

5: :Notes
<ol style="list-style-type: none"> 1. It is unadvisable to take a shower after drunk. 2.It is unadvisable to have a shower immediately after acute sports. 3.Please avoid bath or shower in morning. 4.Keep the temperature of dressing room near to the bathroom. 5.If you feel uncomfortable while having a shower , you should go out of the shower room as soon as possible. 6.The time of shower is advisable to be between 15 minutes and 20 minutes, no longer . 7.Drink water to supplement moisture after shower or bathing. 8.People who suffer from heart disease, high blood pressure, diabetes or who feel unwell or pregnant woman are unadvisable to have bathing ,massage or shower.
6: Delivery and storage notices
<ol style="list-style-type: none"> 1,It is prohibited to store organic solvent together, such as formic acid and methanol. 2.Handle with care if it need transport.Heavy stress, mechanical impact and sharp pounding is prohibited. 3.It should keep it dry and airy and make sure there is no etchant gas.

(16)

4: Installation Procedure

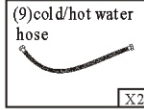
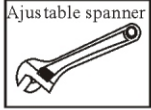

10. Connect cold and hot water hose with installed shower room by adjustable spanner, then plug in .

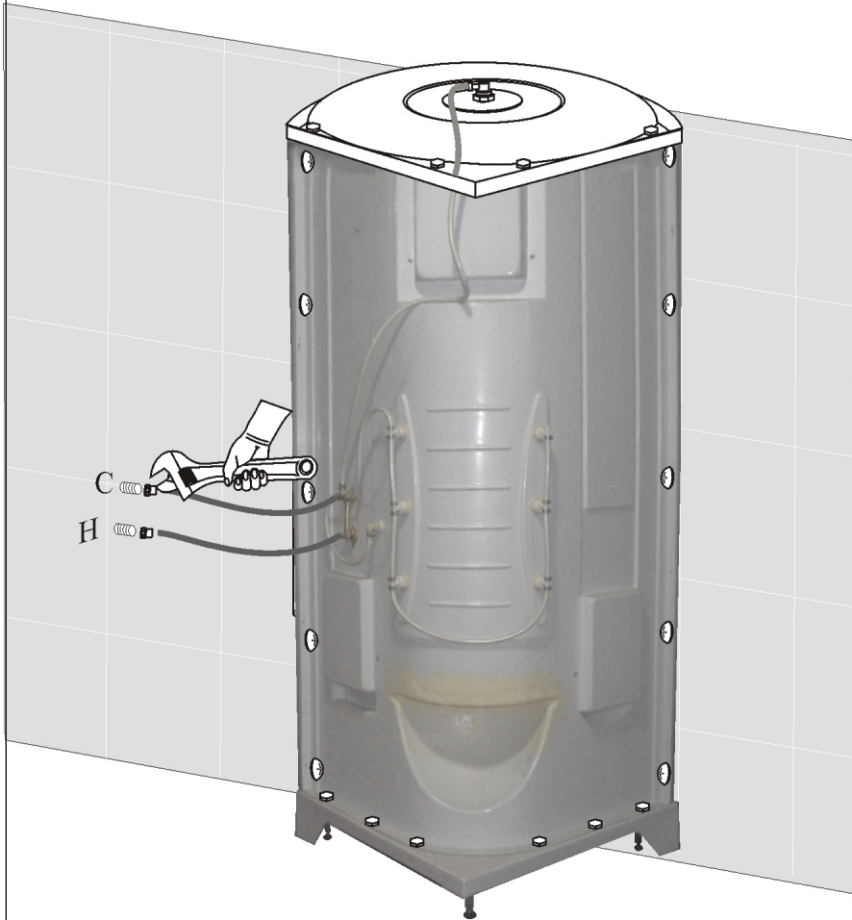

(15)

2:Accessory list

Items	Name	Accessory	Quantity
7	(7.1)handle shower		1
	(7.2)handle shower hose		1
	(7.3)Handle shower shelf		1
8	(8)shelf		2
9	(9)cold/hot water hose		2
10	(10)positioning fixture		8
11	(11.1)Magnetic belt		2
	(11.2)Waterproof belt		2
	(11.3)Ushaped belt		4
12	(12.1)St 4*60mm self tapping screw		8
	(12.2)St 4*12mm self tapping screw		12
	(12.3)St 4*16mm self tapping screw		10
	(12.4)M 6*30mm srew arbor		12

(4)

3: Pipe and drain installation drawing

C= cold water inlet
H= Hot water inlet
D= Drain



(5)

4: Installation Procedure

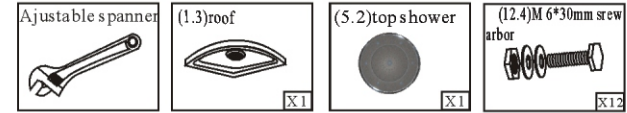

9. Fix top shower to the roof, and move it on the glass room and backboard, tighten by M6*30MM screws arbor.

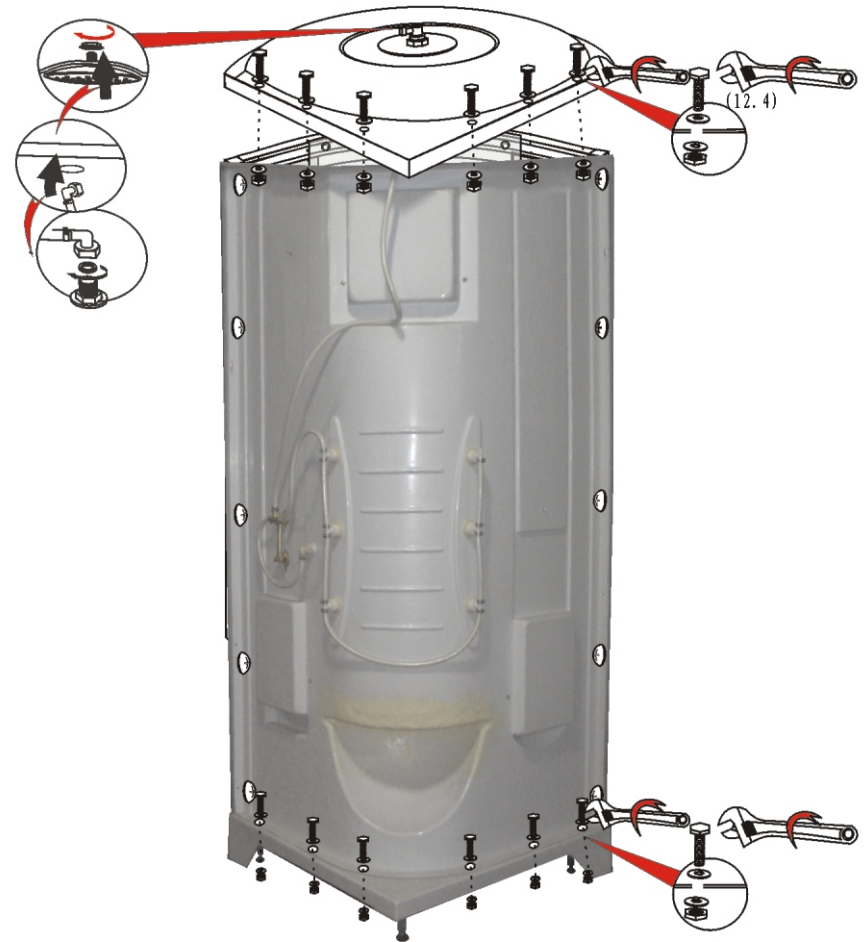

(14)

4: Installation Procedure

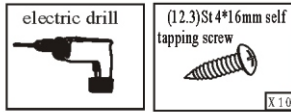

8. Use electric drill to connect shower room backboard edge and side upright column by ST4*16MM screws.



(13)

4: Installation Procedure

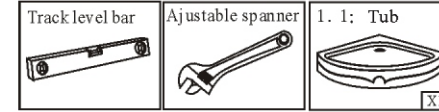

1. Place the base on a solid floor and adjust the feet so that it is level. Check carefully using a spirit level. Remove film before installation.

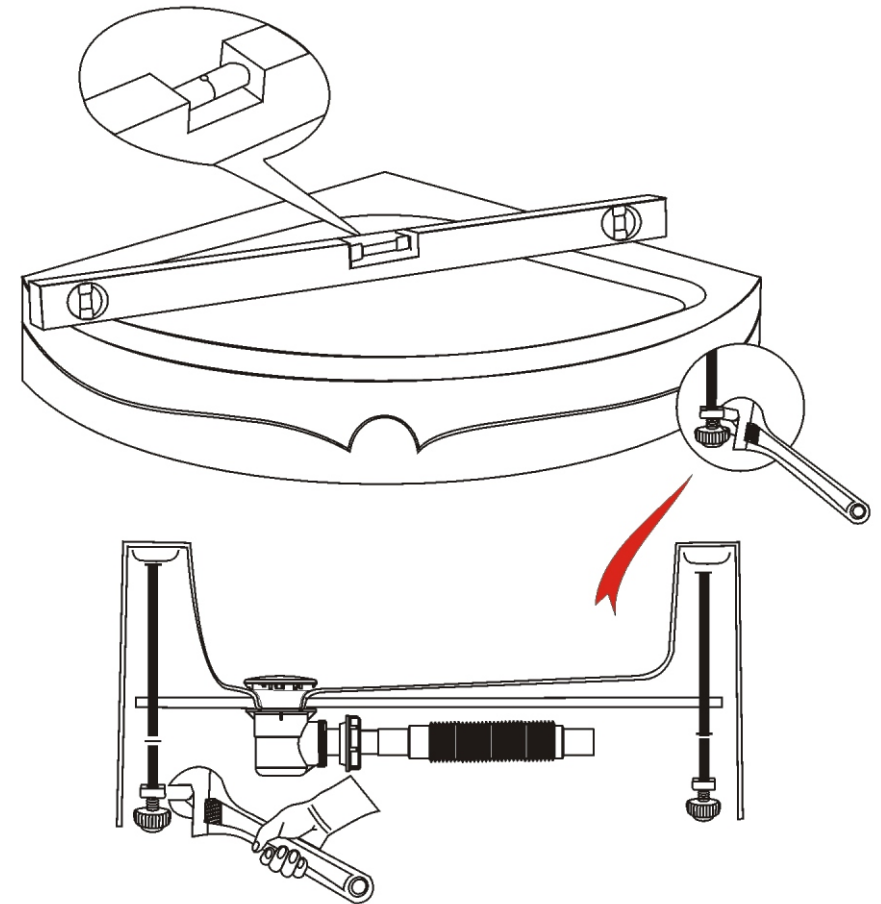

(6)

4: Installation Procedure

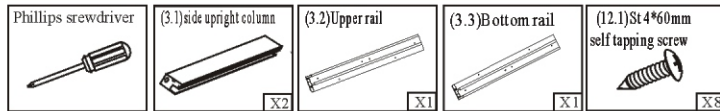

2. Connect up and down rails with inner side upright column, tighten by St4*45mm self tapping screws, then connect side upright column.

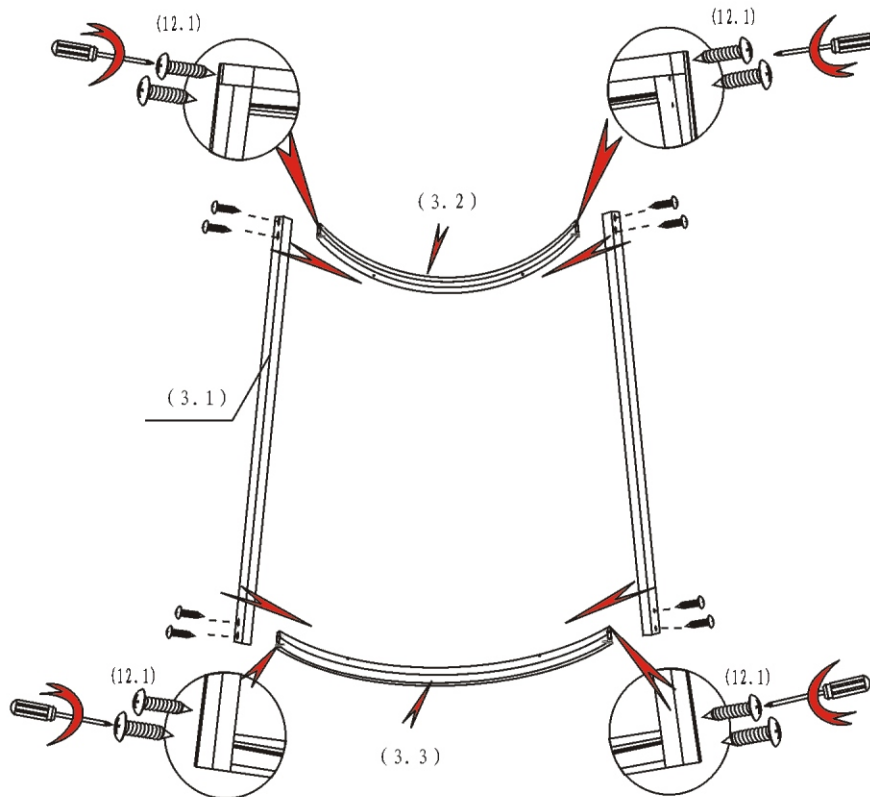

(7)

4: Installation Procedure



7. Fix all accessory in the backboard as pic.

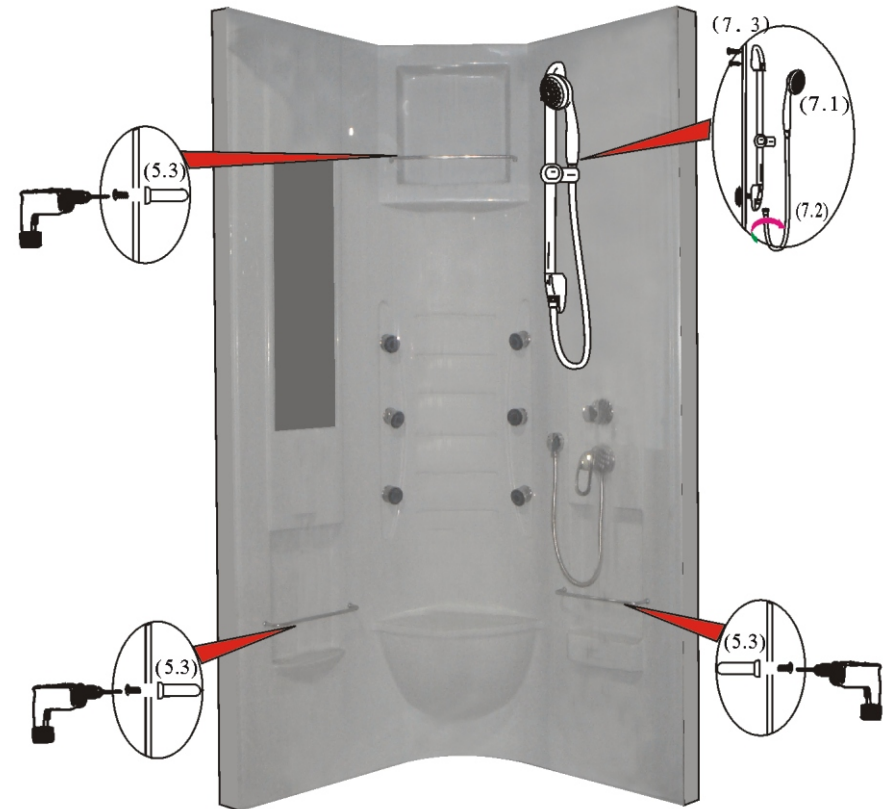

(12)

4: Installation Procedure

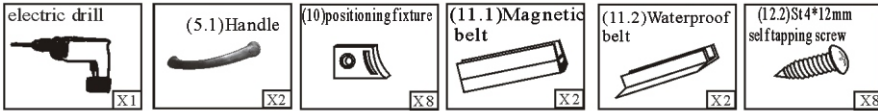

6. Fit handle into the door holes, fix them by its screws. Fix the location bar and magnetic seal, blocking water seal.

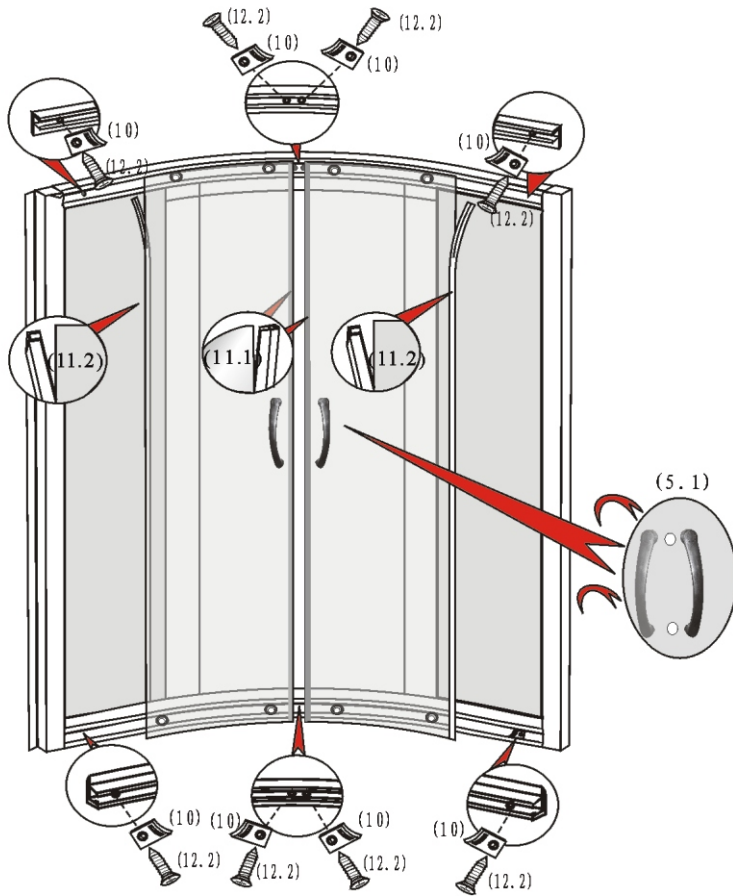

(11)

4: Installation Procedure

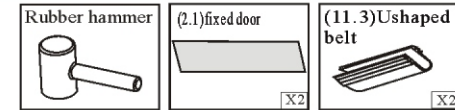

3. Hit slightly the glass into the curve of inner upright column by rubber hammer after fitting U shaped belt with left and right fixed glass.

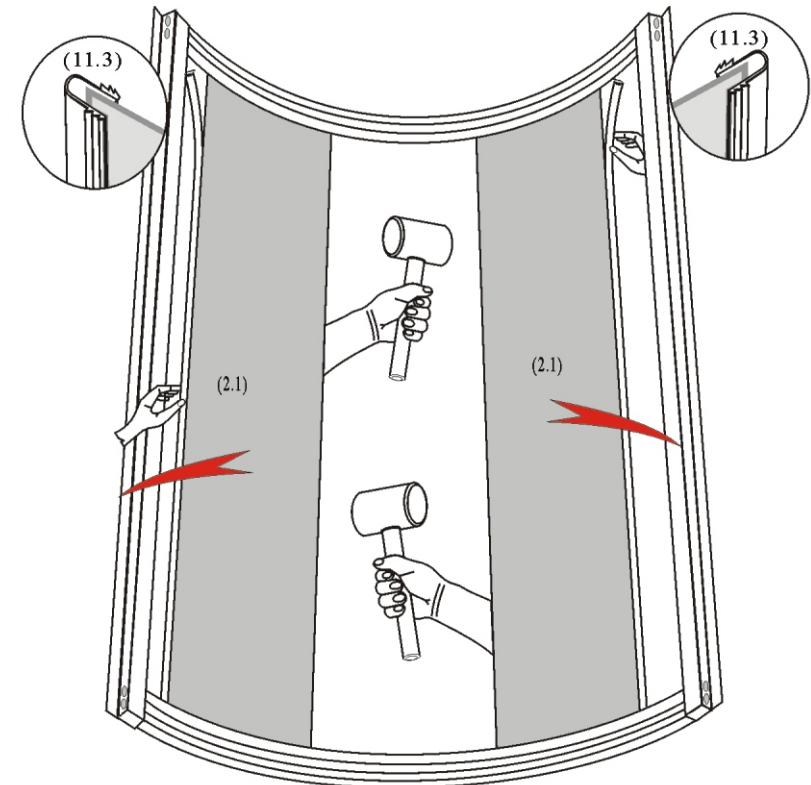

(8)

4: Installation Procedure

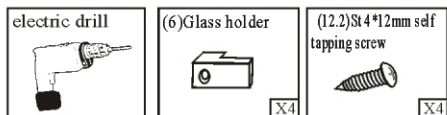

4. Fix up glass positioning item by St4*12mm screws, then fix side upright column.

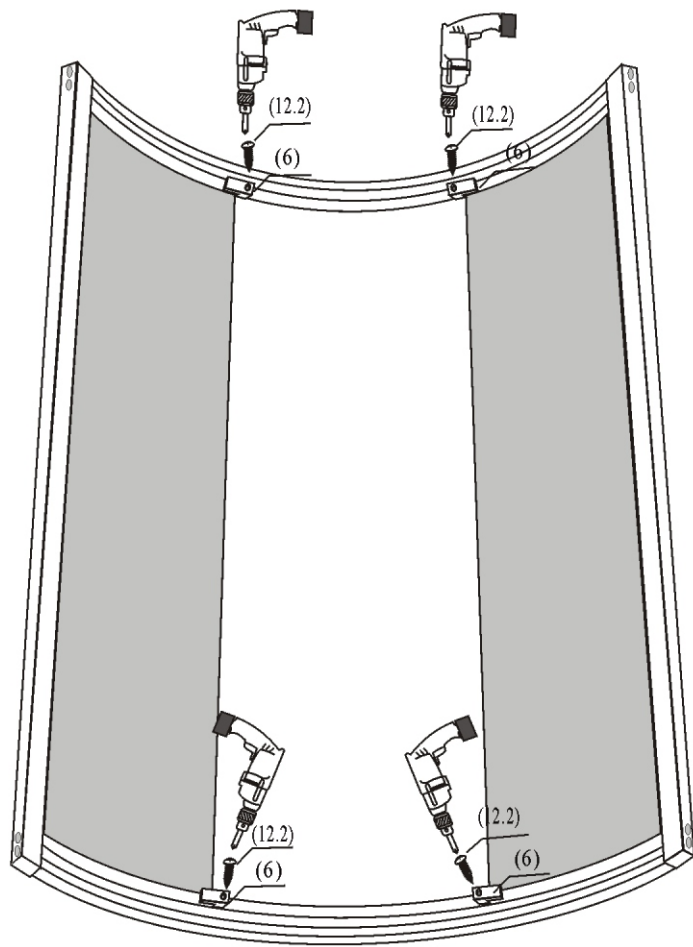

(9)

4: Installation Procedure

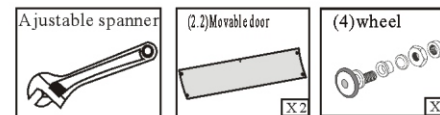

5. Install eccentric wheel to the hole of flexible door glass, then connect it to down rail, fix side upright column.

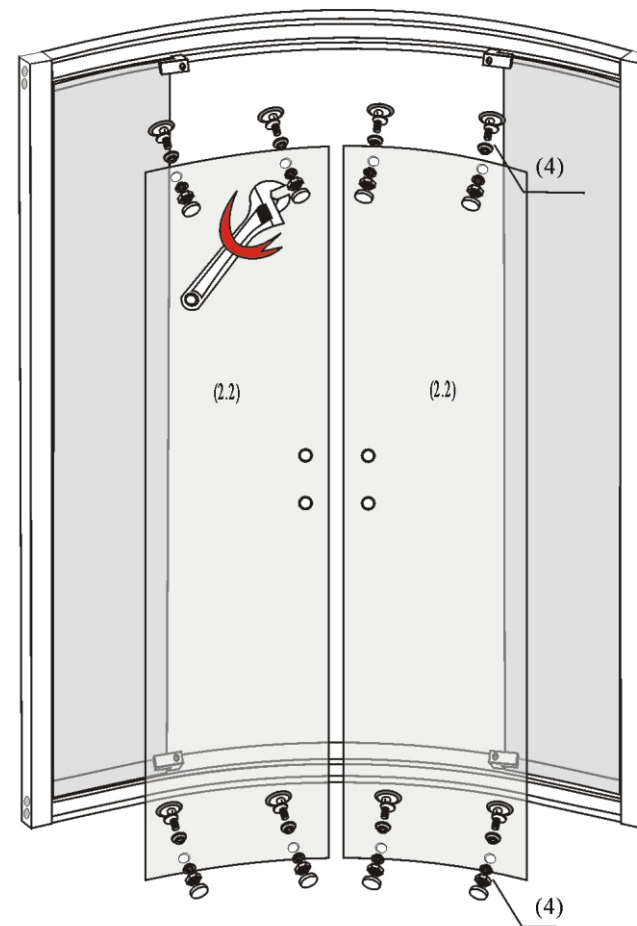

(10)